

## Product technical sheet

# ACTIVE 2703



14+



< 140 kg



19,7 m<sup>2</sup>

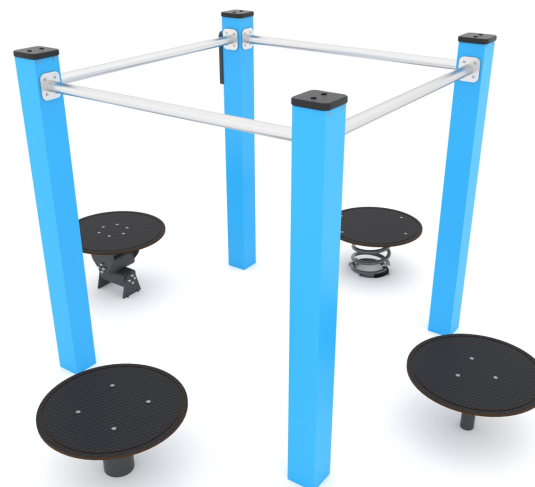

### Product data

Length	225 cm
Width	225 cm
Total height	130 cm
Age group	14+ years
Maximum weight of user	140 kg
Safety zone	19,7 m <sup>2</sup>
Free fall height	< 60 cm
In accordance with norm EN	16630:2015
Weight of the heaviest part	21 kg
Dimensions of the largest part	230x10x10 cm
Availability of spare parts	YES
Installation time	4 h
Color options	

Data is subject to change without prior notice.

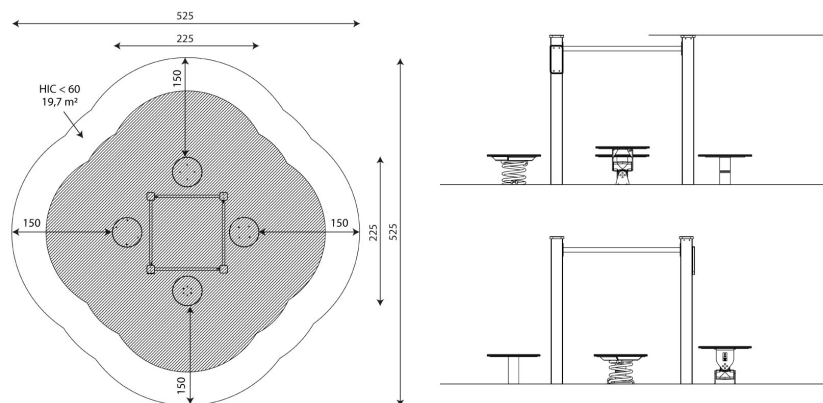

Vinci Group Sp. z o.o.  
Seminaryjna 9 Street  
99-400 Łowicz

VAT: 534-250-14-46  
PHONE: +48 42 203 24 99 ext. 26  
M: +48 793 404 991

15/12/2023



biuro@vinci-play.com  
info@vinci-play.com  
[www.vinci-play.com](http://www.vinci-play.com)

## Material specification



Powder galvanized and powder-coated or stainless steel construction of 100 x 100 mm profile, durable end caps on the top of the structure made of plastic,



Platforms and steps made of durable anti-slip and waterproof HPL plate,



Aluminum exercise instructions plate screwed to HDPE plate, resistant to weather conditions,



Steel springs 20 mm, iron phosphorated and powder coated,



Stainless steel bars and handrails,



Moving elements based on a durable braking system closed in casings, which do not require greasing and maintenance, ensuring long service life of the device,

## Additional information

- equipment adapted for the disabled; device intended for public outdoor gyms;
- equipment has a certificate issued by an accredited entity or a declaration of conformity;
- no sharp edges or chinks that would pose a danger of jimmieing the head, fingers or any other body parts;
- anchoring on flat surface, 80/70 cm deep;
- render is for reference only, the actual appearance of the equipment and its color may vary;

## Guarantee

- 30** 30 year guarantee - Structural strength of steel and stainless steel components
- 15** 15 year guarantee - Structural failure of steel and stainless steel, for dynamic equipment
- 10** 10 year guarantee - Structural failure of high density polyethylene and high pressure laminates components
- 5** 5 year guarantee - Corrosion of stainless steel and hot dip galvanized and powder coated components; against bark beetles and rot in case of wooden structural elements

Detailed information in the guarantee card

Vinci Group Sp. z o.o.  
Seminaryjna 9 Street  
99-400 Łowicz

VAT: 534-250-14-46  
PHONE: +48 42 203 24 99 ext. 26  
M: +48 793 404 991

biuro@vinci-play.com  
info@vinci-play.com  
[www.vinci-play.com](http://www.vinci-play.com)



## Amount of safe surface corresponding with free fall height:

HIC <60 19,7 m<sup>2</sup>

Data is subject to change without prior notice.

## Surfaces according to EN 16630:2015

	Description (mm)	Layer thickness (cm)	Maximum fall height (cm)
Concrete / stone / bituminous surfaces (A, B, C)	-	-	≤100
outer soil layer (A,B,C)	-	-	≤120
Turf (A,B,C)	-	-	≤150
bark (A,C)	Particle size from 20 to 80	30	≤200
		40	≤300
wood shavings/cuttings (A, C)	Particle size from 5 to 30	30	≤200
		40	≤300
sand (A,C)	Particle size from 0,2 to 2 mm	30	≤200
		40	≤300
gravel (A,C)	Particle size from 2 to 8	30	≤200
		40	≤300
attested synthetic (A, B, C)	Tested according to EN 1177		< 60



Vinci Group Sp. z o.o.  
Seminaryjna 9 Street  
99-400 Łowicz

VAT: 534-250-14-46  
PHONE: +48 42 203 24 99 ext. 26  
M: +48 793 404 991

biuro@vinci-play.com  
info@vinci-play.com  
[www.vinci-play.com](http://www.vinci-play.com)

