

# Product Datasheet

## Park Bench DLP04

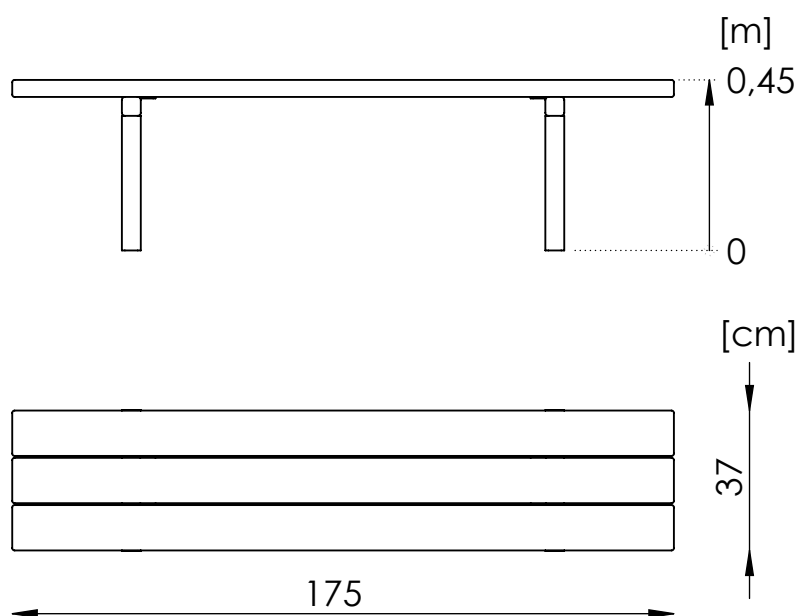

### Materials used:

- structure of the bench legs made of profile 50x50 mm and a flat bar 4x40 mm, hot dip galvanized
- backrest and bench seat made of boards with a section of 45 mm, pressure impregnated
- fasteners, hardened galvanized screws

### Assembly:

The set is mounted in the ground using hot-dip galvanized steel anchors.  
Foundations made of C20/25 class concrete.