

SANDBOX - SQUARE

PRODUCT COMPOSITION

EPDM, aliphatic PU binder, SBR + LECA mix

COLOR COMBINATION

Various colors available on request

COLOR STABILITY

UV stable

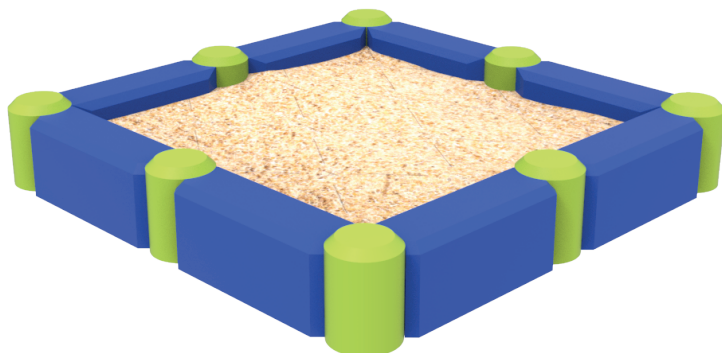

RECOMMENDED SAFETY SURFACE

safety rubber surface
(no safety area required according to EN1177)

PRODUCT SAFETY

certified according to EN1176
complies with ASTM F1487 and CAN/CSA Z614

INSTALLATION

the product is installed onto a concrete foundation

PACKAGING

wrapped in plastic and delivered on a pallet
of a size according to number of pieces

STORAGE

in original packaging on a pallet
in temperatures between - 40° C and 50° C

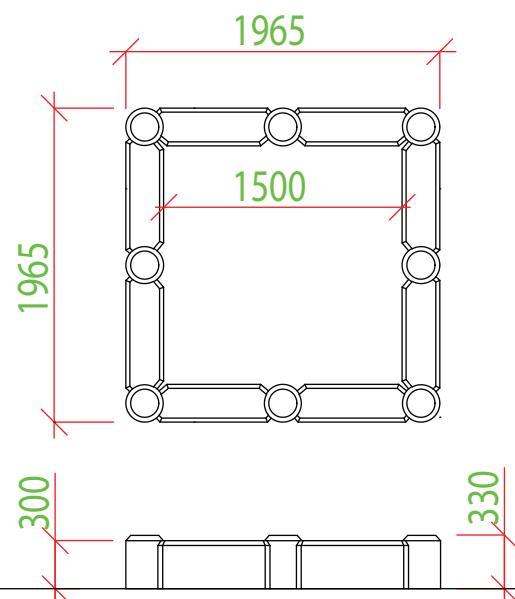
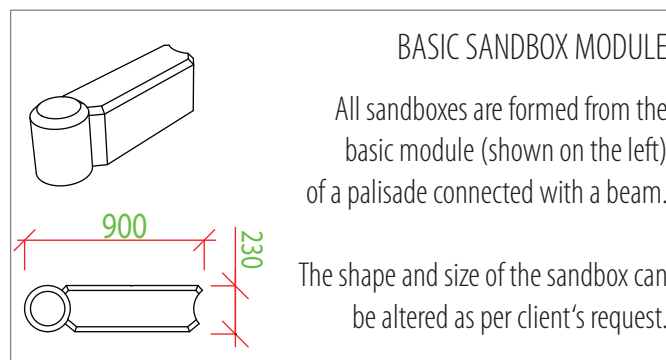

Our products are handmade, please allow dimensional tolerance up to 10 mm

200 kg weight	<600 mm critical fall height	8 hr assembly time	0 - 8 yrs users' age	>5 max. number of users	1965 x 1965 x 330 mm dimensions
-------------------------	---	------------------------------	--------------------------------	--------------------------------------	---

3D PROGRAM, s.r.o.

Objízdná 1911
Otrokovice 765 02
Czech Republic

www.3dprogram.eu
info@3dprogram.eu
+420 602 500 045 +420 577 700 718



SANDBOX - OCTAGON

PRODUCT COMPOSITION

EPDM, aliphatic PU binder, SBR + LECA mix

COLOR COMBINATION

Various colors available on request

COLOR STABILITY

UV stable



RECOMMENDED SAFETY SURFACE

safety rubber surface

(no safety area required according to EN1177)

PRODUCT SAFETY

certified according to EN1176

complies with ASTM F1487 and CAN/CSA Z614

INSTALLATION

the product is installed onto a concrete foundation

PACKAGING

wrapped in plastic and delivered on a pallet of a size according to number of pieces

STORAGE

in original packaging on a pallet

in temperatures between - 40° C and 50° C

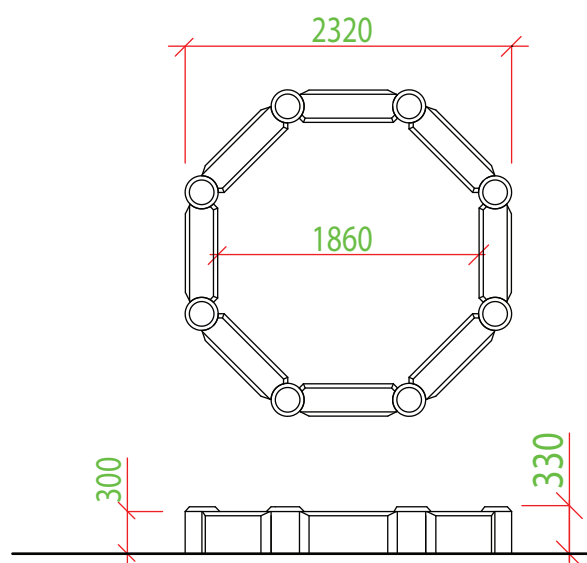
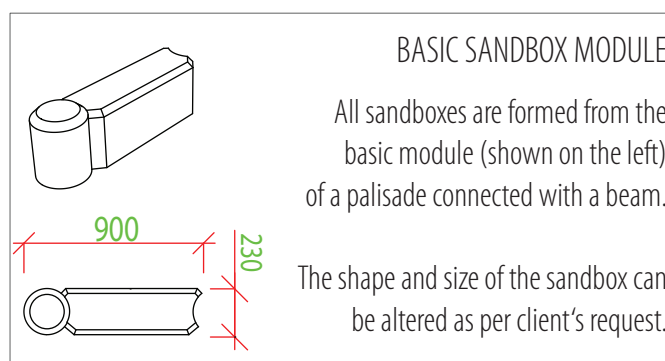

Our products are handmade, please allow dimensional tolerance up to 10 mm

200 kg weight	<600 mm critical fall height	8 hr assembly time	0 - 8 yrs users' age	>5 max. number of users	2320 x 2320 x 330 mm dimensions
-------------------------	---	------------------------------	--------------------------------	--------------------------------------	---

3D PROGRAM, s.r.o.

Objízdná 1911
Otrokovice 765 02
Czech Republic



www.3dprogram.eu
info@3dprogram.eu
+420 602 500 045 +420 577 700 718

