

5 11 501 0110 0

**ecorino slide ascent PH  
145, solo**







made in germany

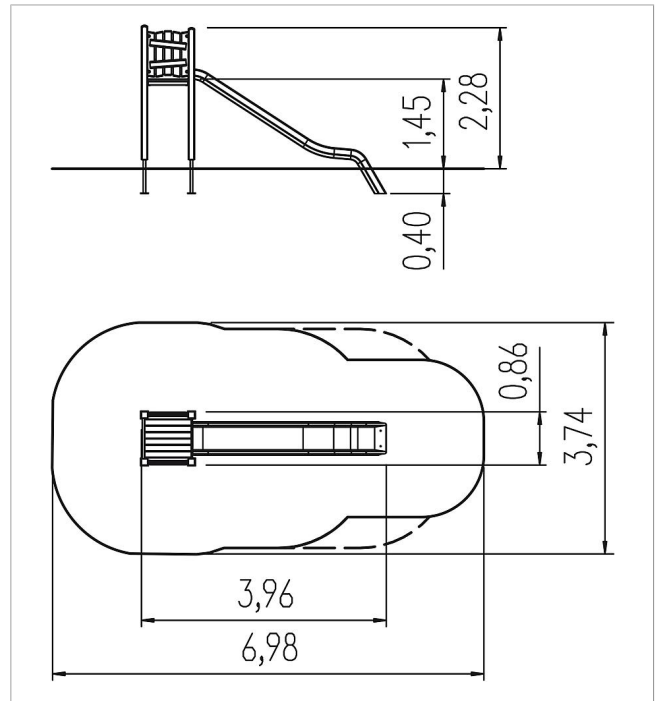

### Scope of delivery

4x post construction: SW or steel  
 4x post shoe: steel galvanised  
 1x platform construction: SW  
 2x wall panel wood: SW  
 4x decoration crossbar: SW  
 1x walk-through protection leaf: stainless steel  
 1x set of grips: aluminium, plastic coated  
 2x cord protection: HPL  
 1x ladder vertical: SW, rungs stainless steel  
 1x slide entry plate: HPL  
 Fittings: stainless steel



	Material	SW pi
	Foundation level	FL 1
	Minimum space	698x374x325 cm
	Free falling height	145 cm
	Impact protection net	21,5 m <sup>2</sup>
	Foundations	4x CF or 4x PFs
	Assembly	2 persons/6 h