

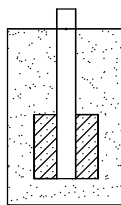

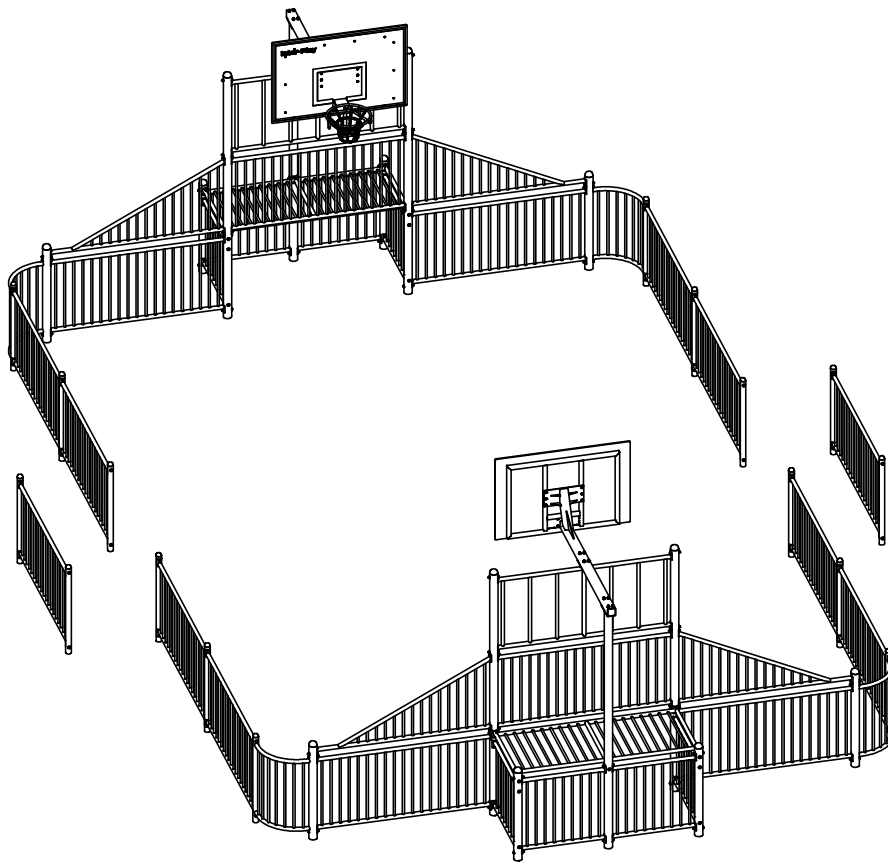

ARENA 1

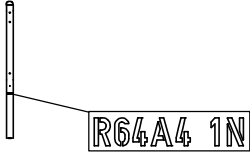
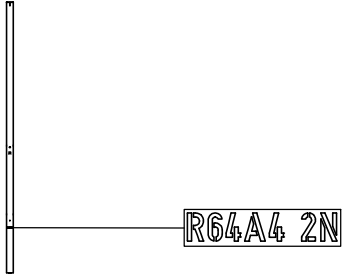

ARENA 1

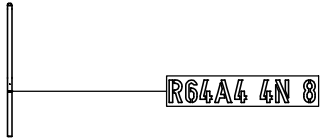

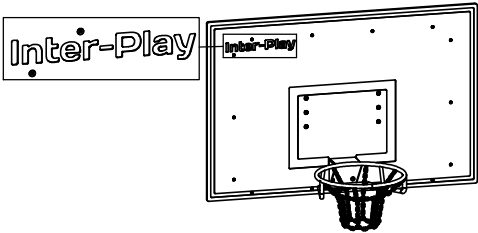
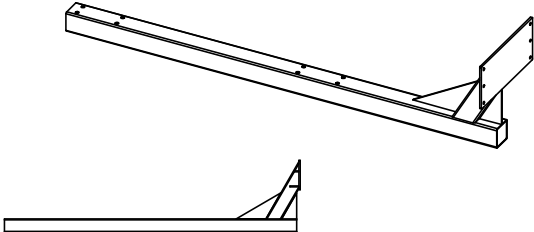
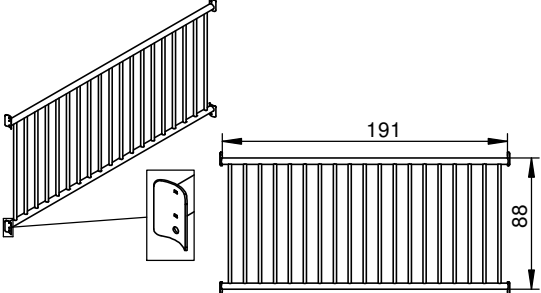
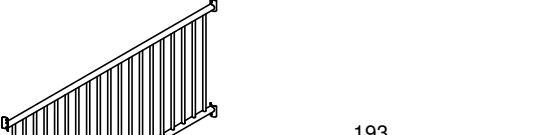
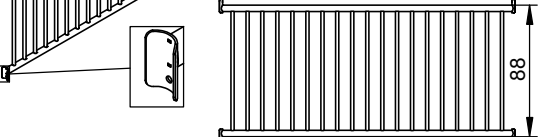
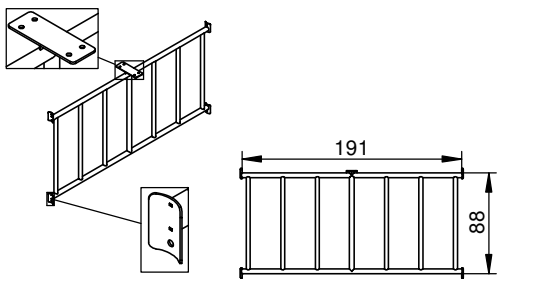
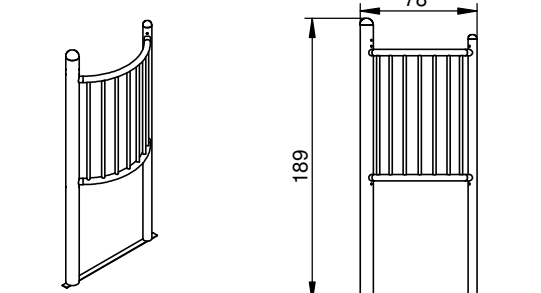
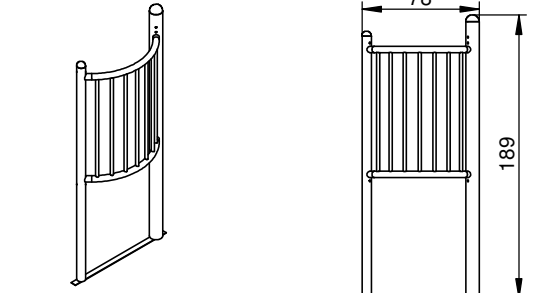
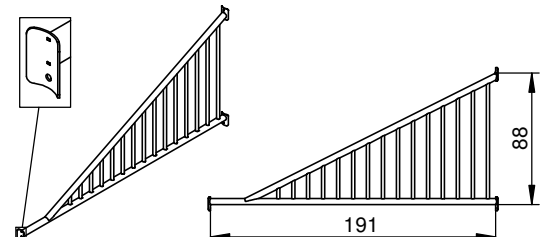

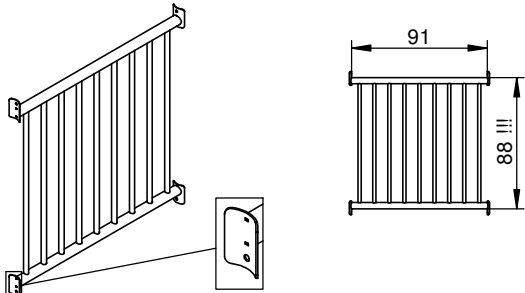
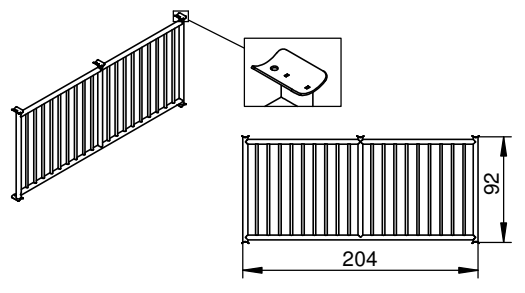
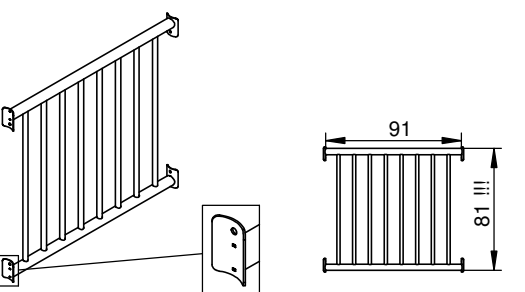
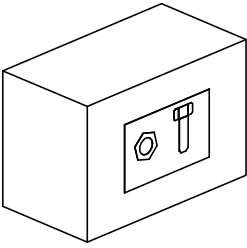

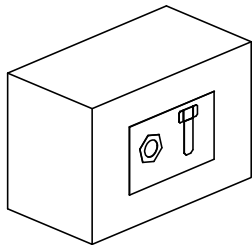

NR	ELEMENT	ARENA 1
E1		4
E2		2
E3		4
E4a		8
E4b		4
E5		2
E6		2

NR	ELEMENT	ARENA 1
E7		6
E8a		8
E8b		2
E9		2
E10		2
E11		2
E12		4

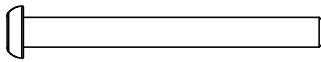
NR	ELEMENT	ARENA 1
E13		4
E14		2
E15		4
E16		1

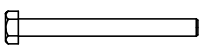
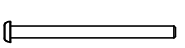
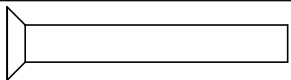

ARENA 1

Nr	Element			Σ
4		DIN 125	10x20	12
21		DIN 125	8x16	232
38		DIN 137A	10x30	232
40		ISO 7380	M8x80	37
43		DIN 1587	M8	116
57		DIN 1587	M10	12
58		-	LOCTITE	1
63		DIN 125	12x24	32
74		DIN 985	M12	16
83		DIN 931	M12x120	16
113		ISO 7380	M8x110	79
187		DIN 7991	M10x75	12

ARENA 1

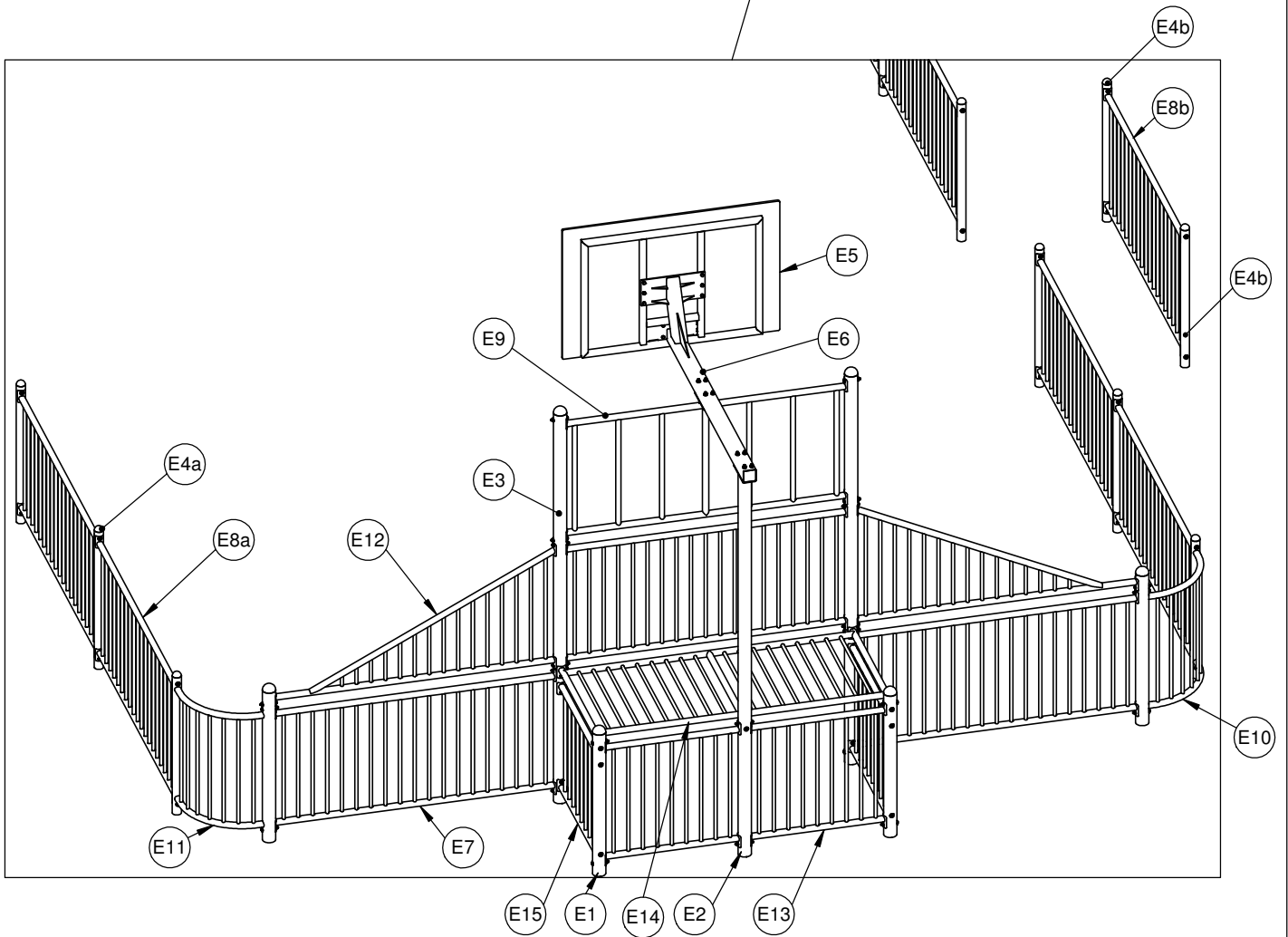
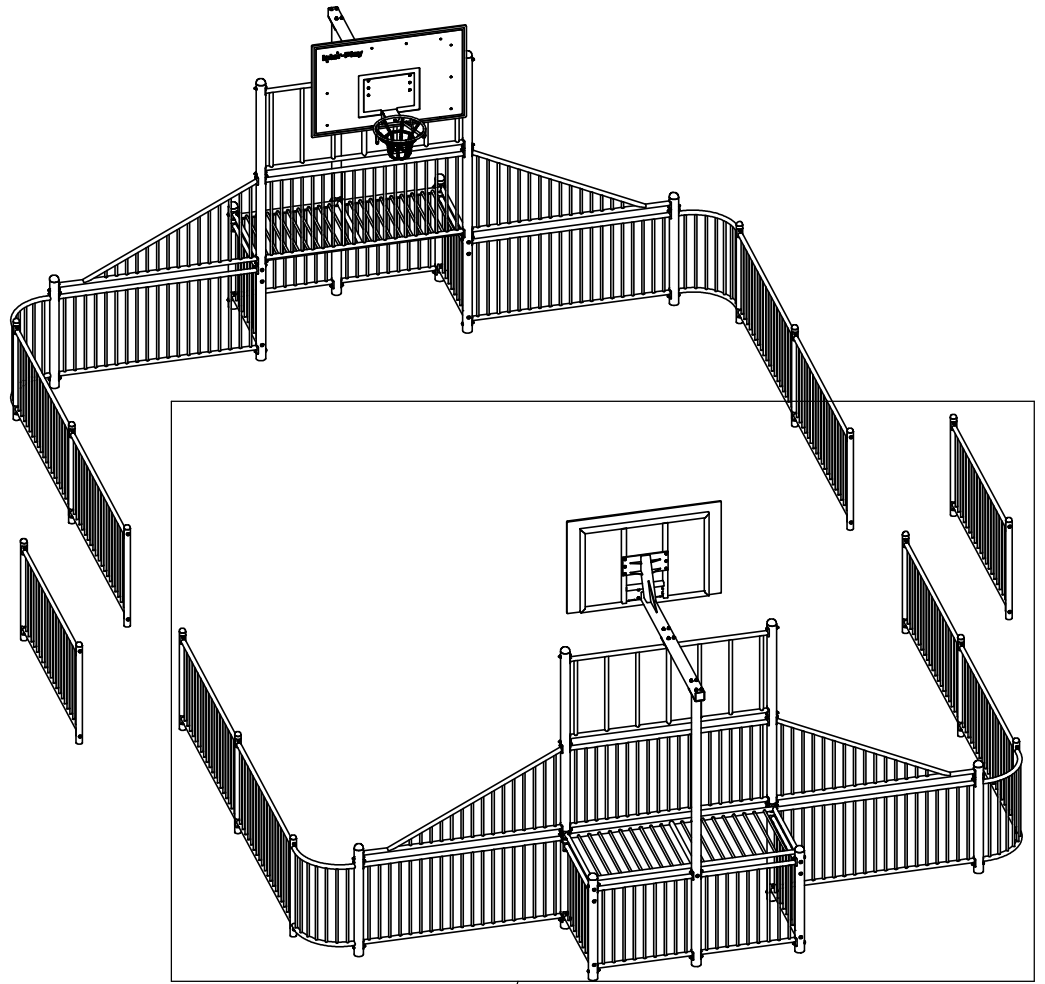

ARENA 1

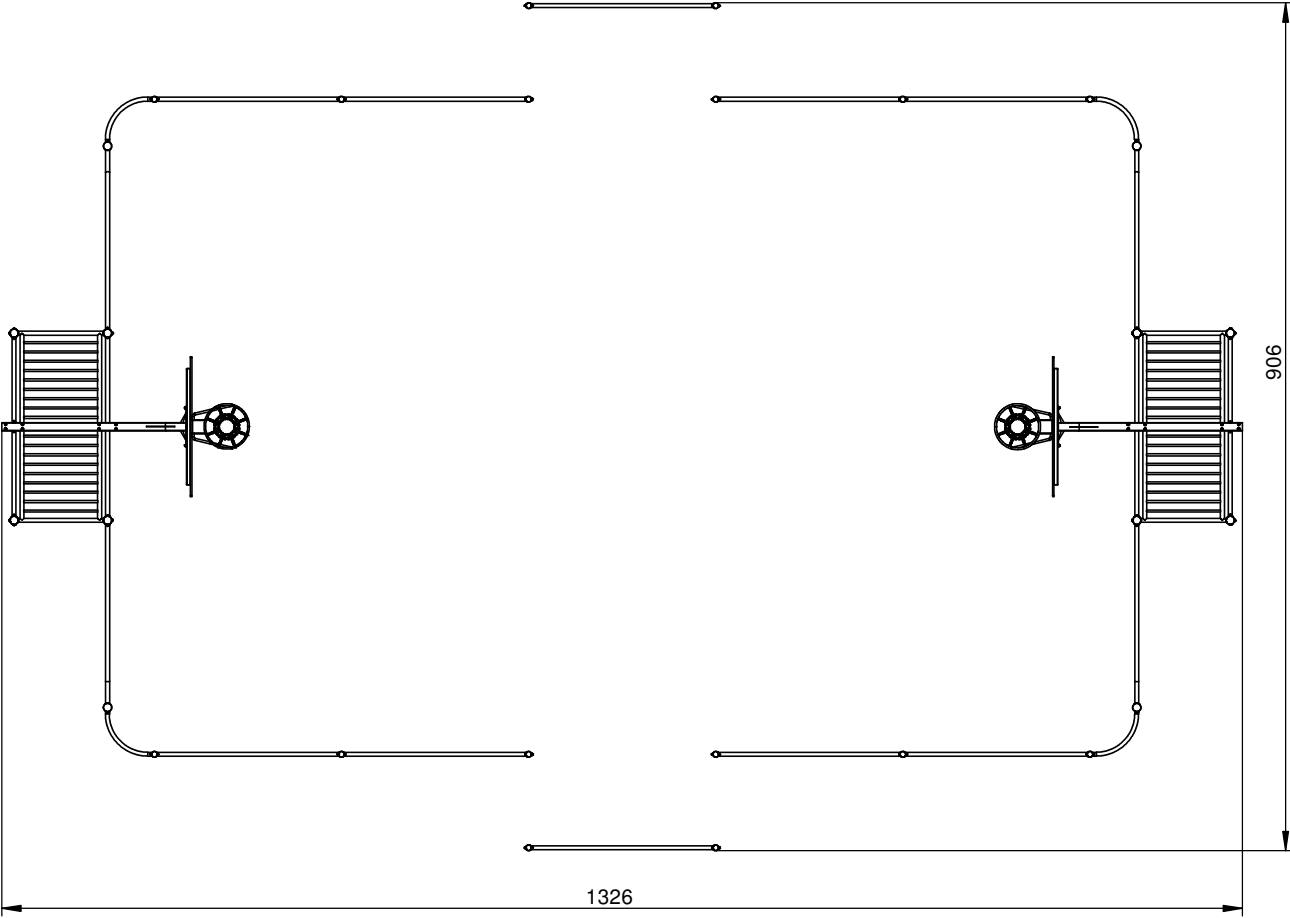
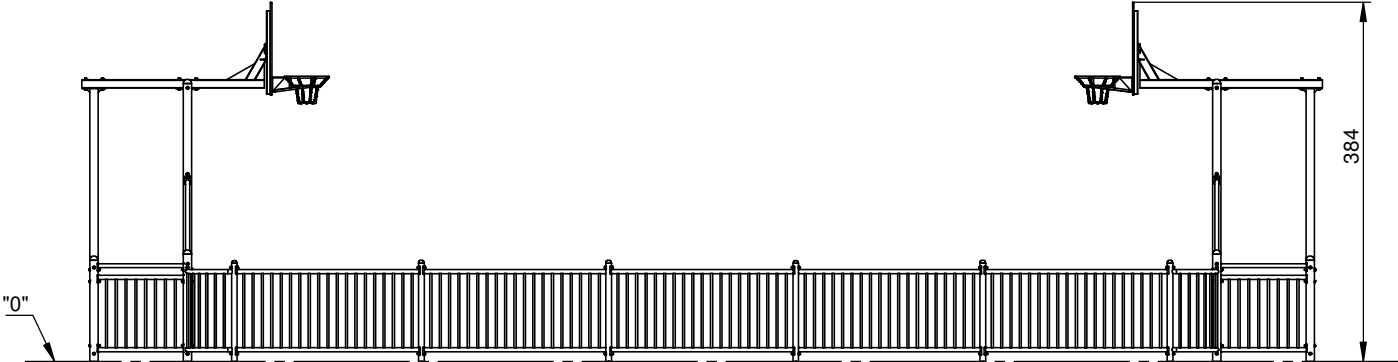

ARENA 1

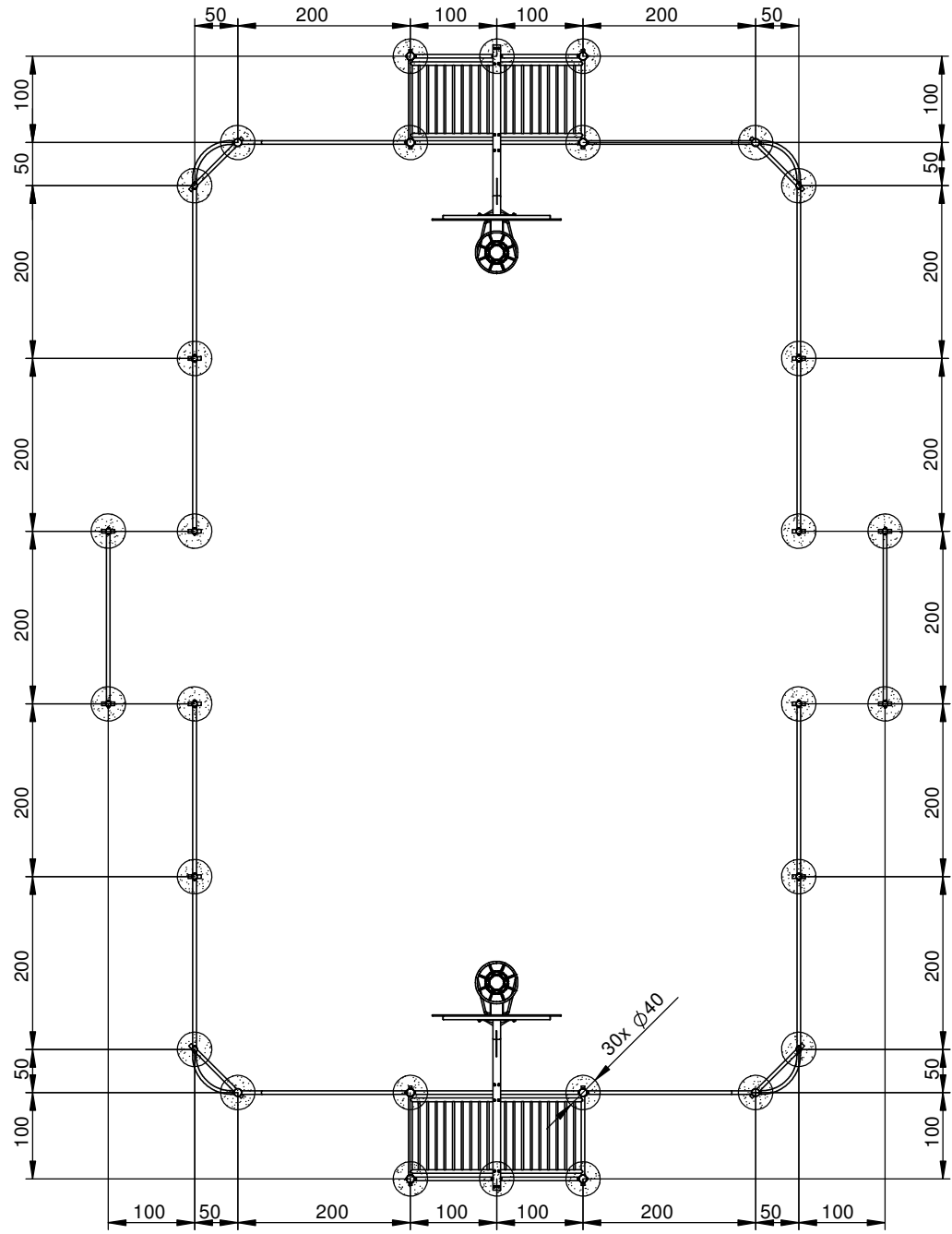
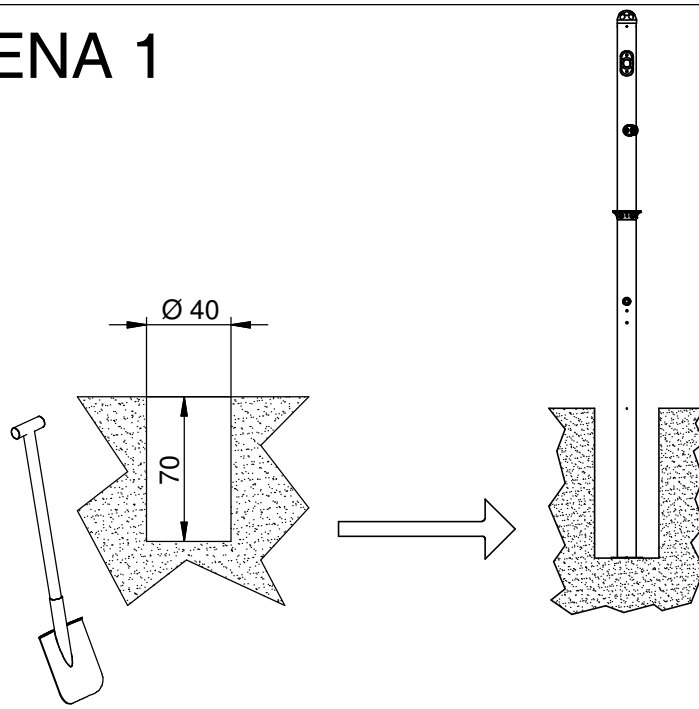

1

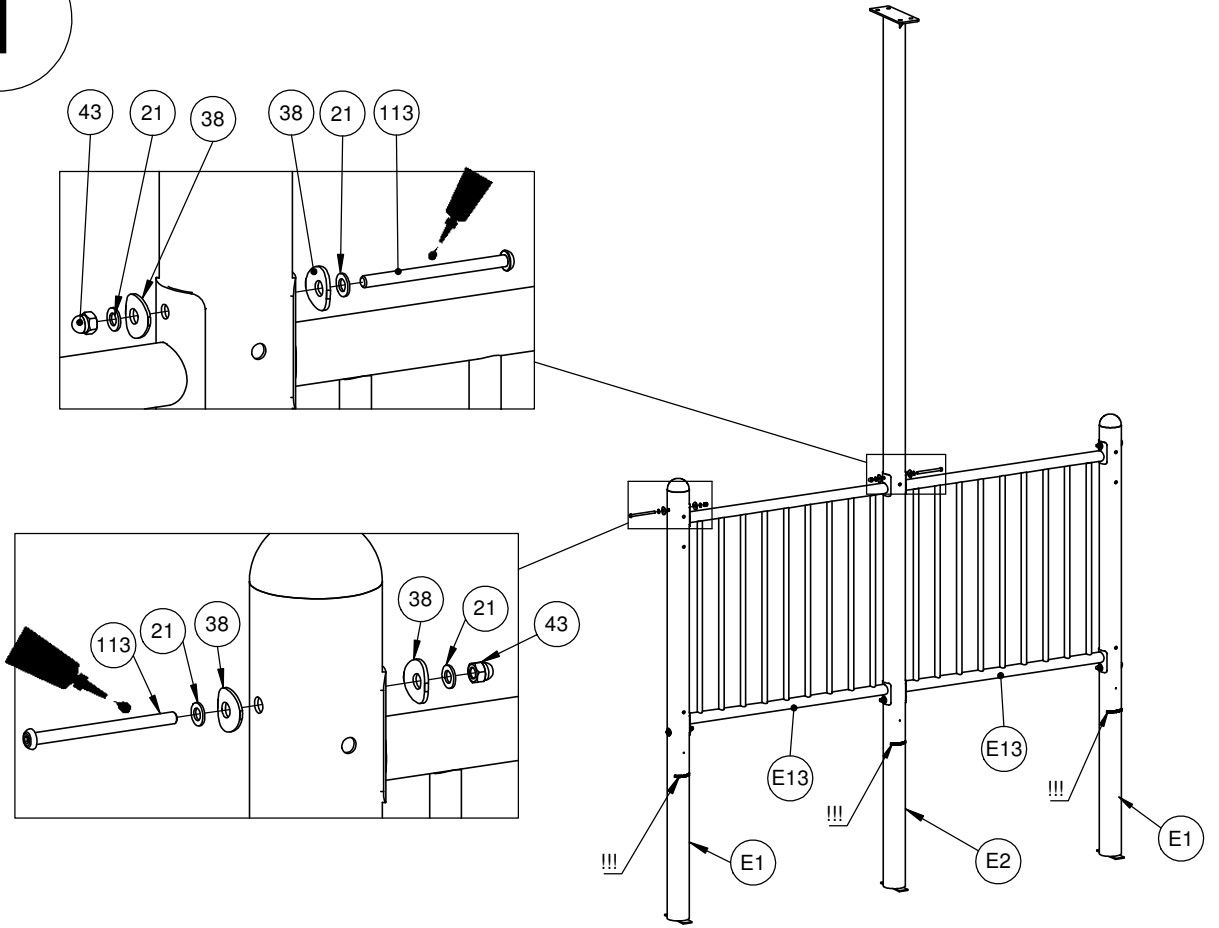

Column codes directed outside the ARENA

2

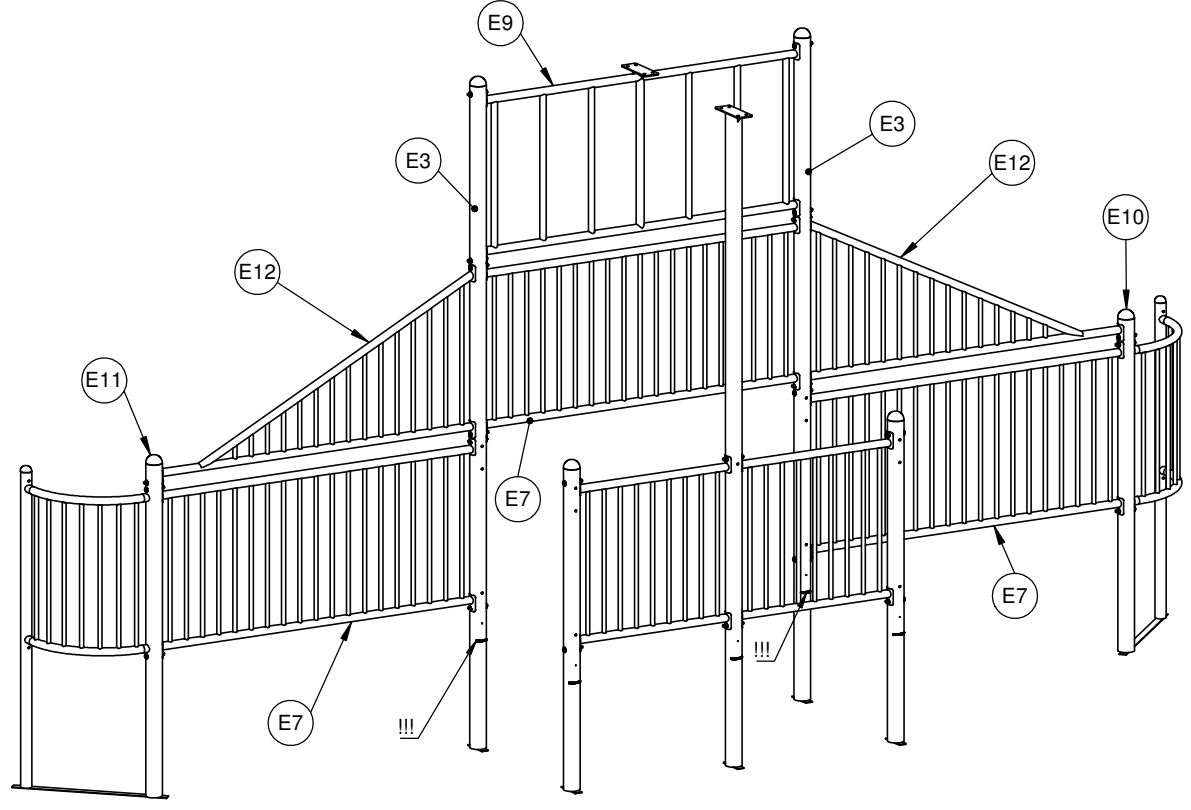

Column codes directed outside the ARENA

3

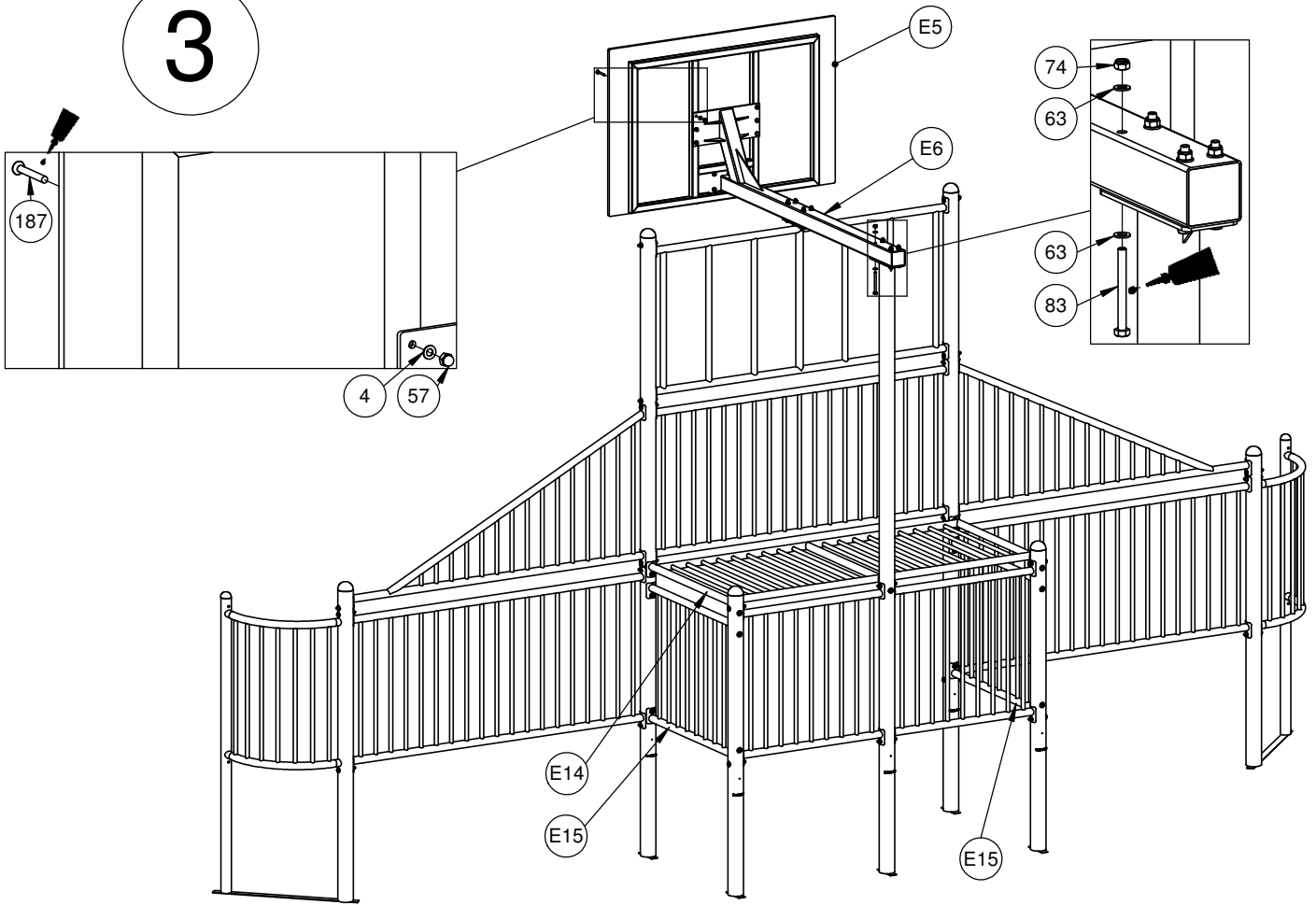

4

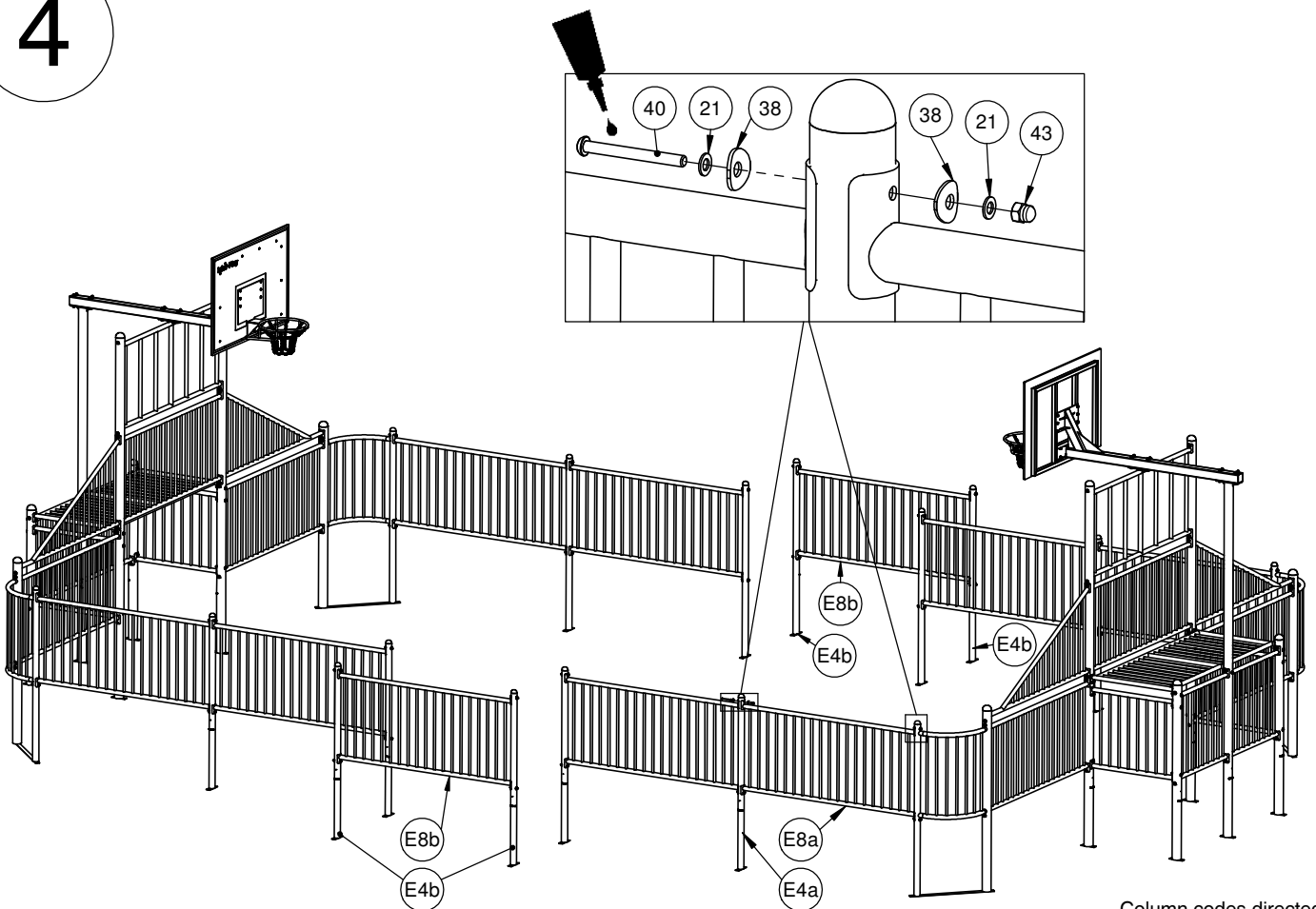

Column codes directed outside the ARENA

ARENA 1

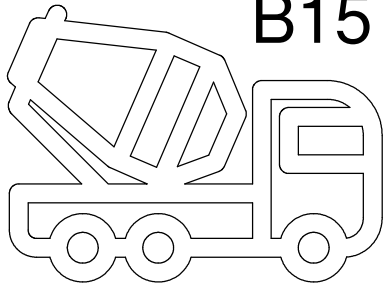

B15 1,2m³

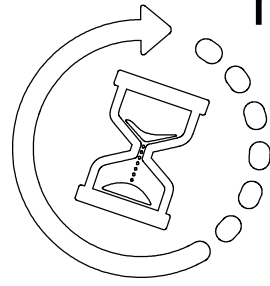

min. 48H

