

1640

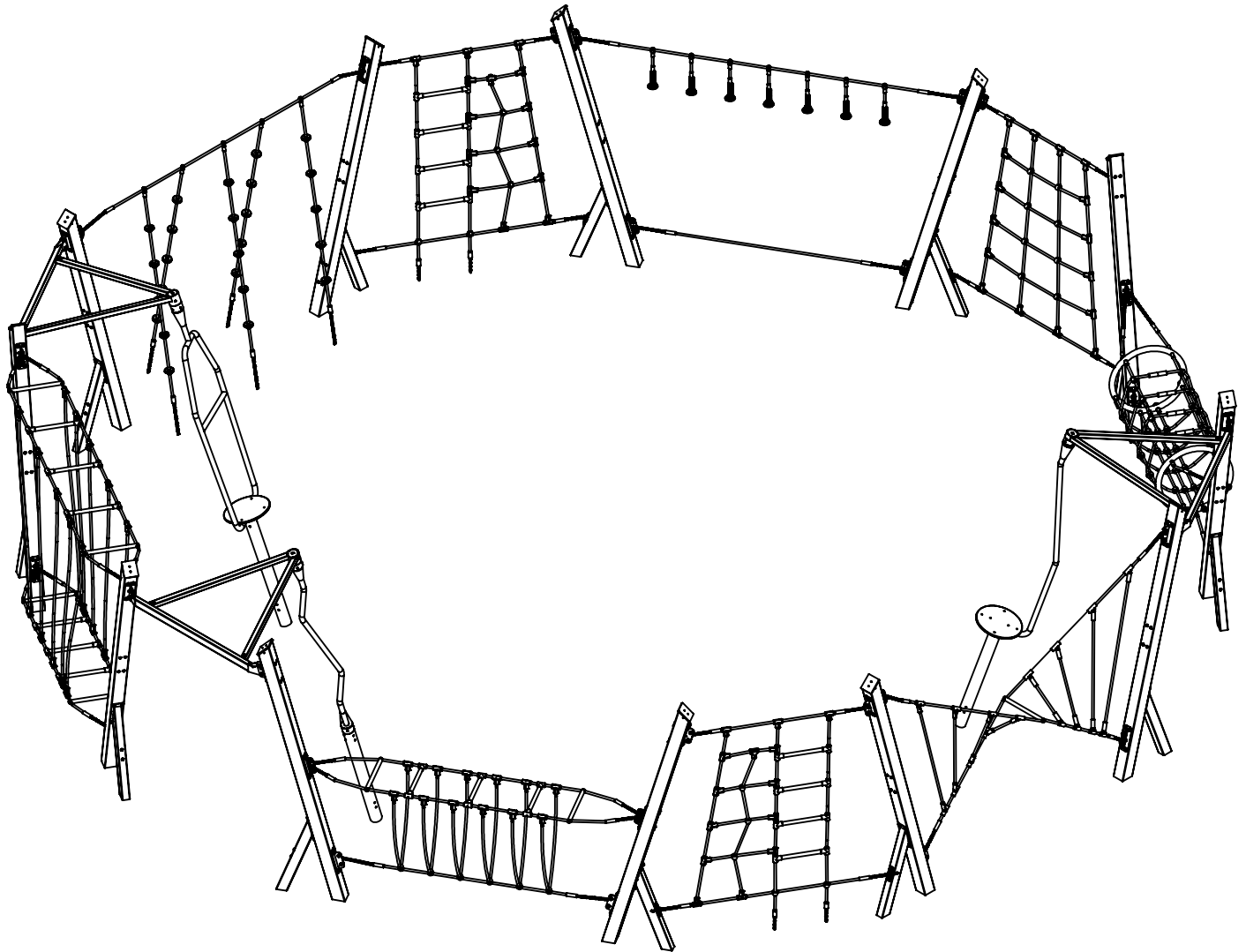

v012
26.01.2022
B. K.
[cm]

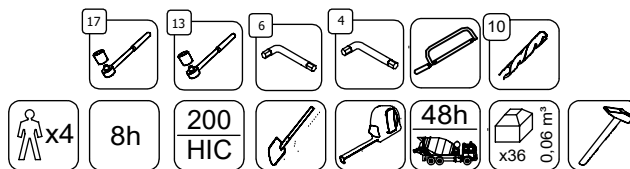

vinci
play

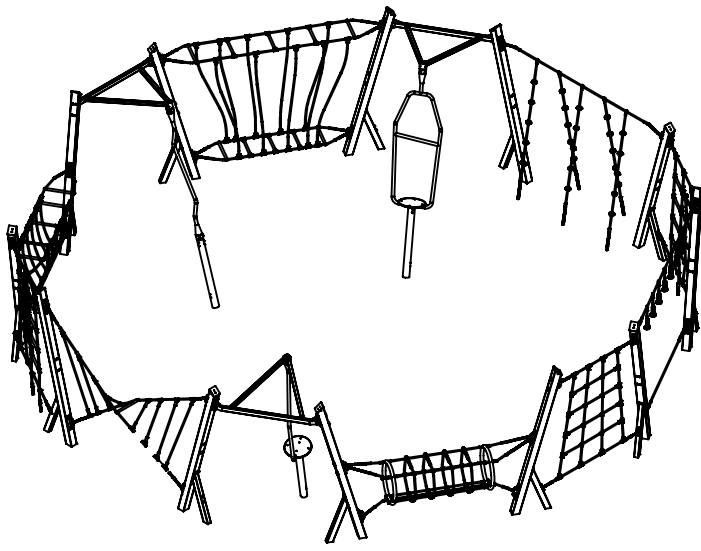
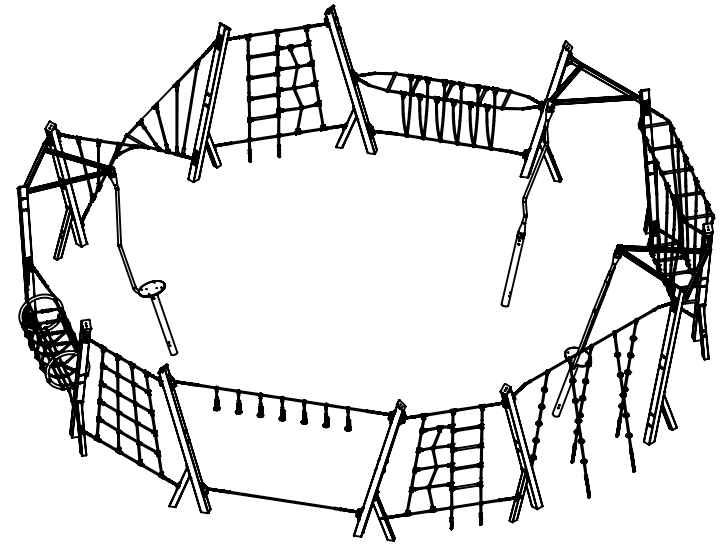
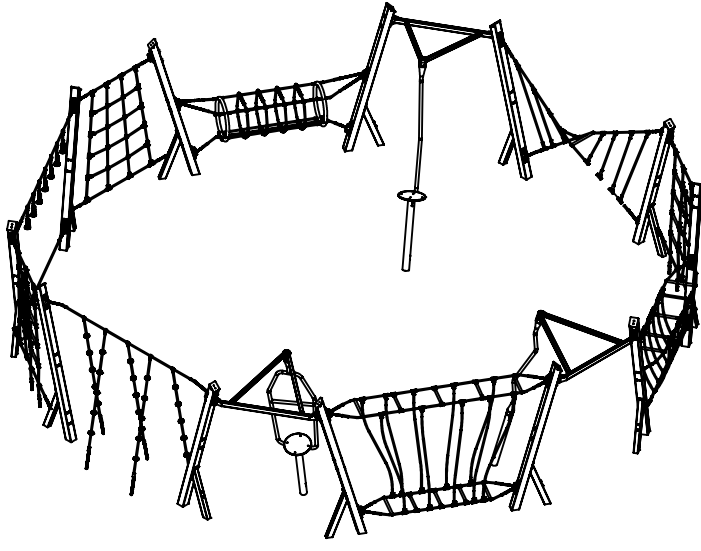
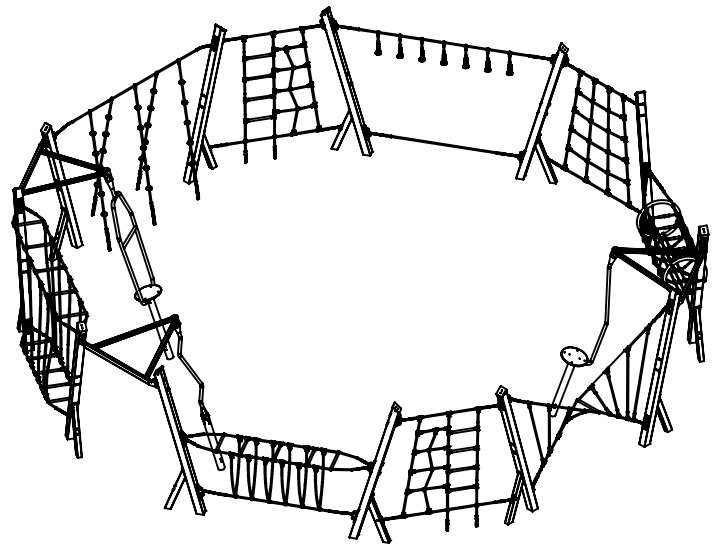

[cm]

vinci
play

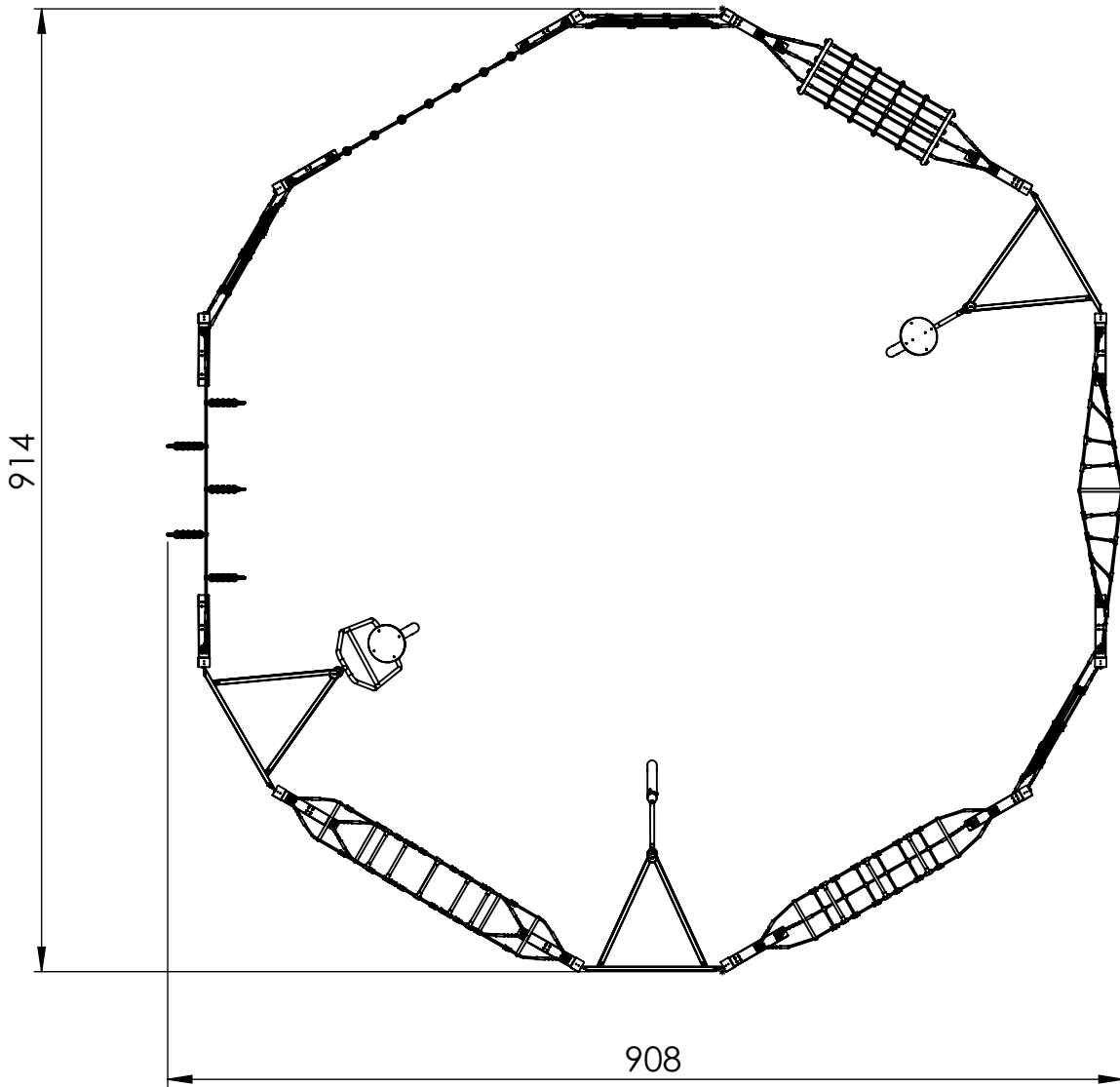
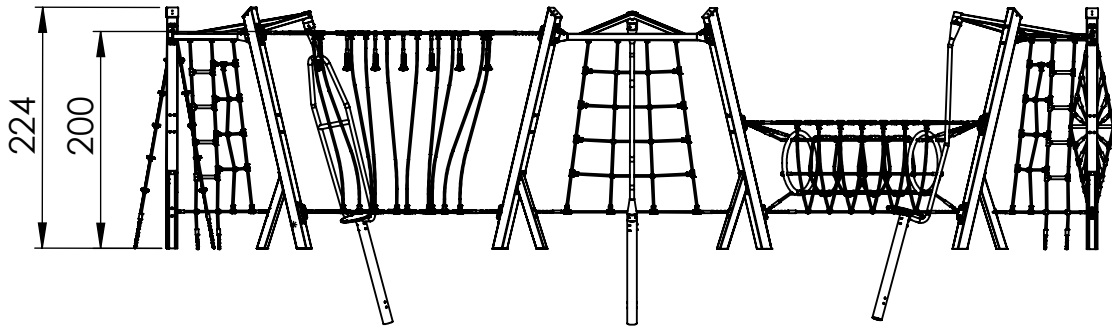

[cm]

vinci
play

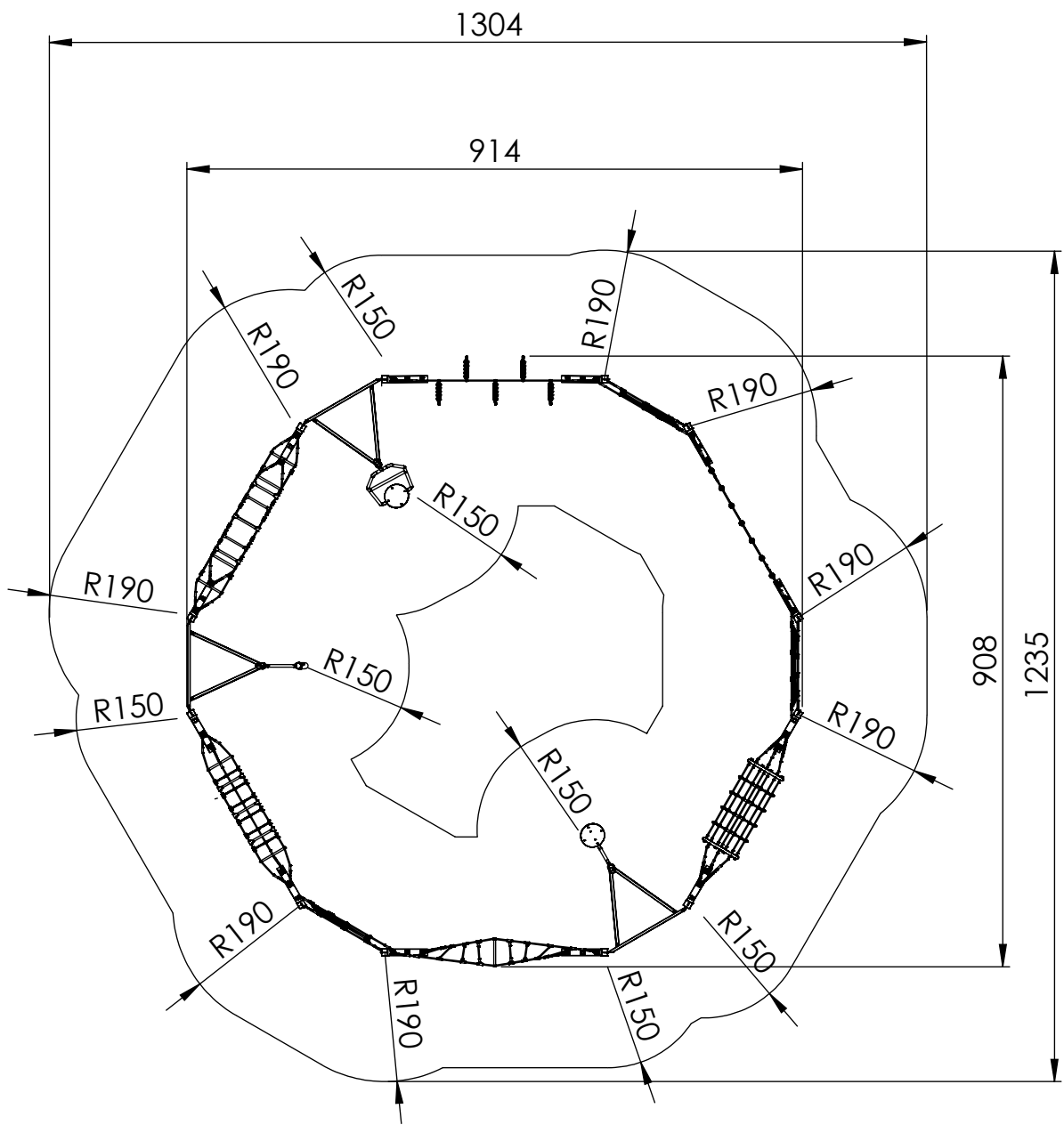

[cm]



vinci
play

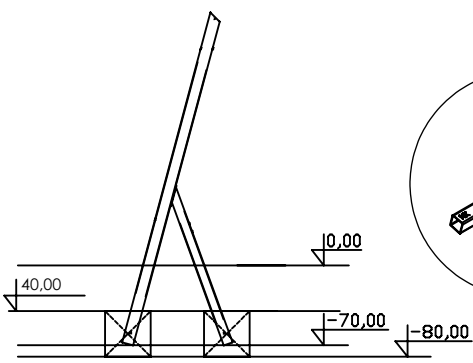

E90

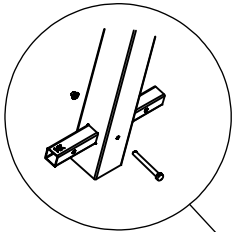

E1

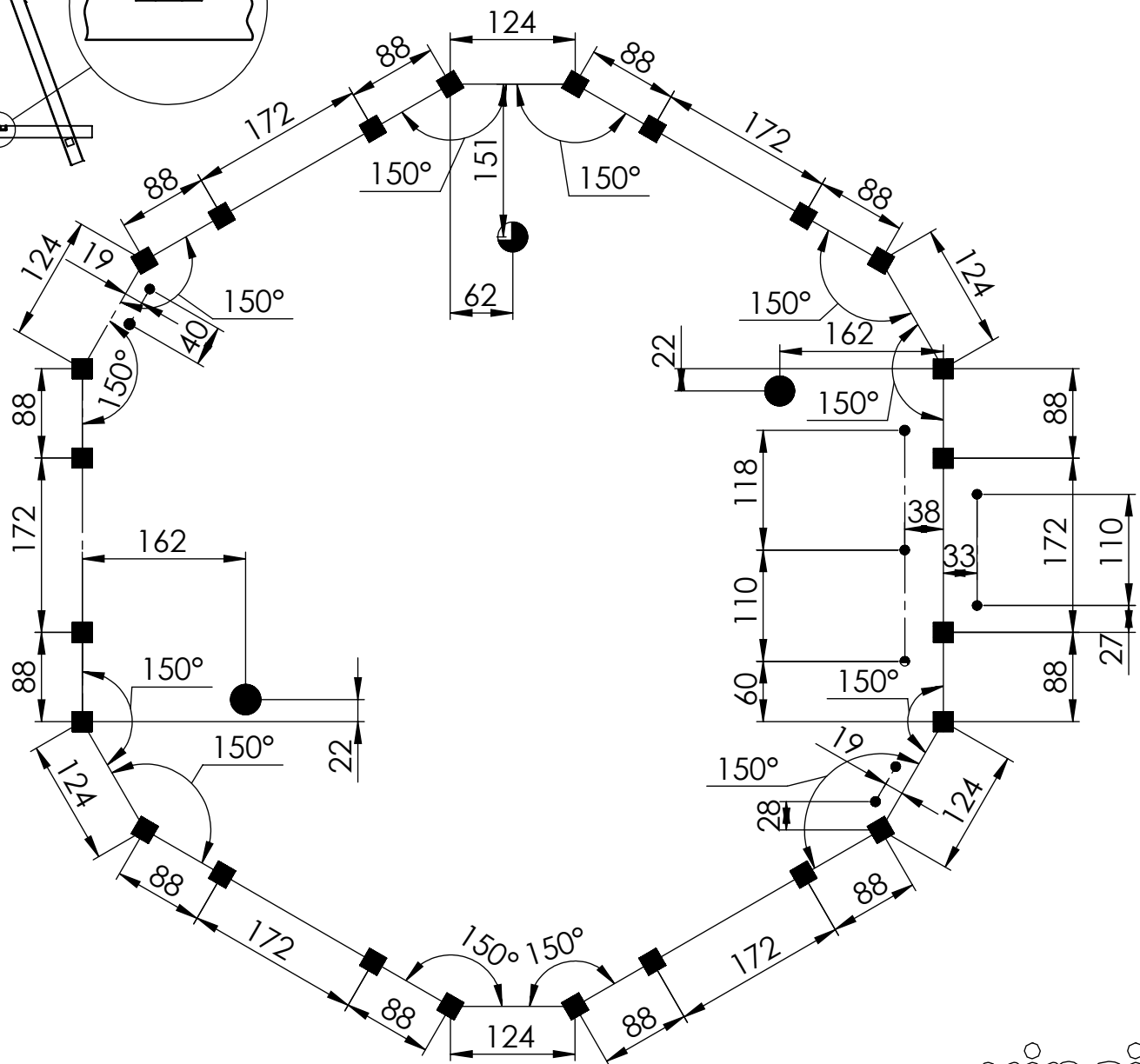
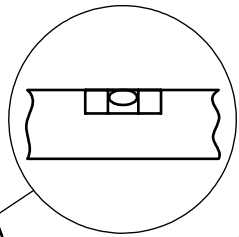
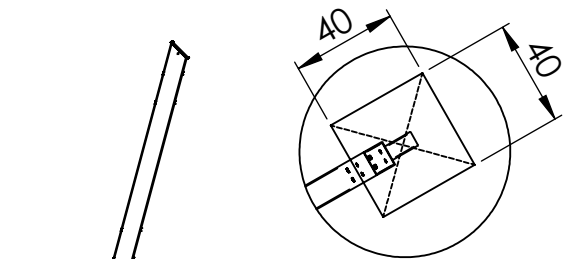
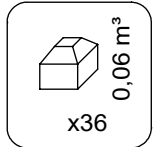
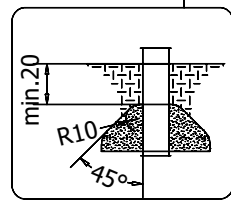
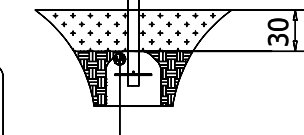
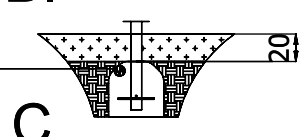
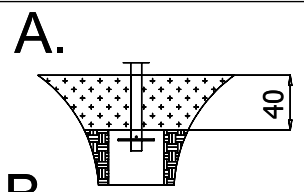
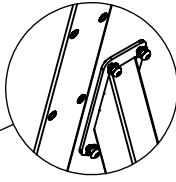

[cm]

x4
 8h

 x36 0,06 m³
 48h

vinci play

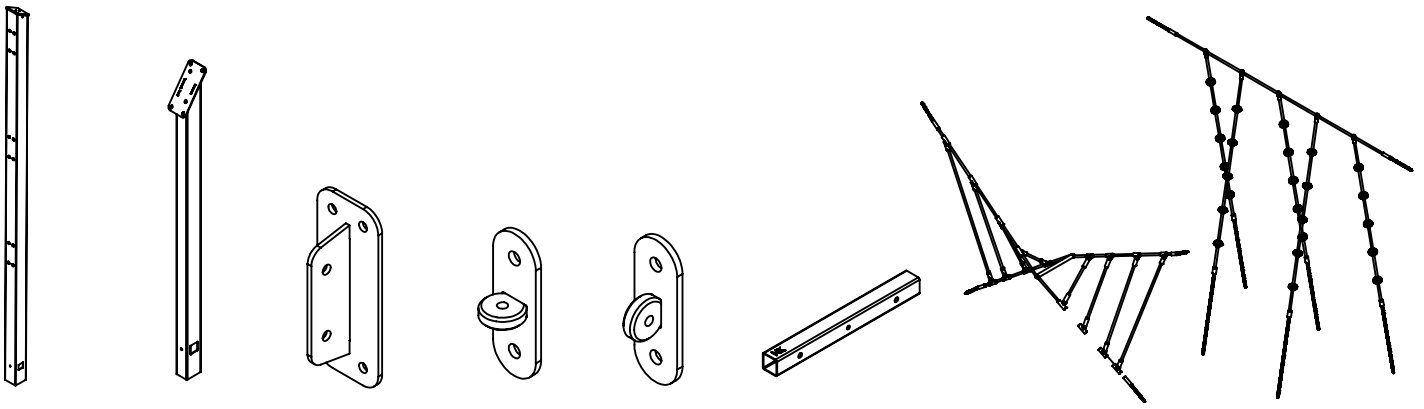

164104 x12 **162100** x12 **162101** x34 **162102** x36 **162103** x6 **NK_kotw_1** x24 **165101** x1 **165102** x1

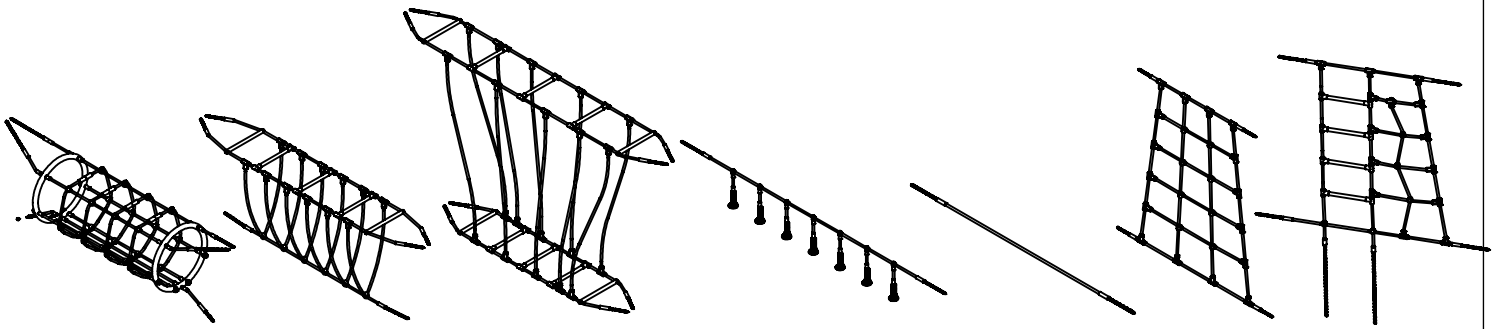

165103 x1 **165104** x1 **165105** x1 **165108** x1 **165116** x1 **165111** x1 **165112** x2

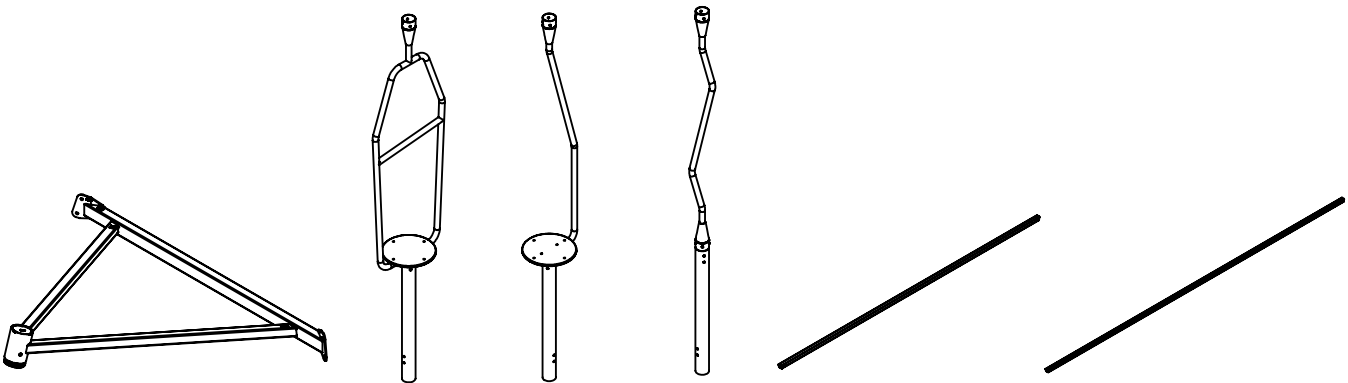

164100 x3 **164101** x1 **164102** x1 **164103** x1 **163100** x5 **163101** x4

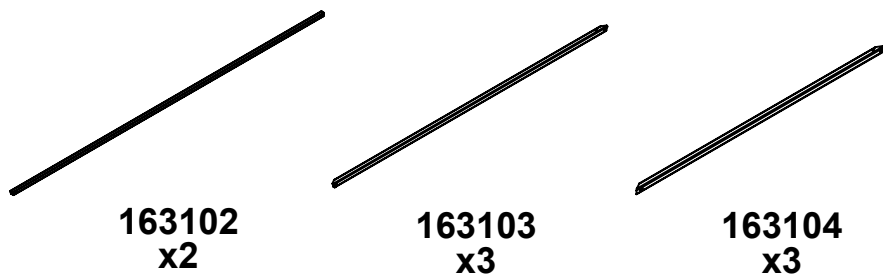

163102
x2

163103
x3

163104
x3

10x	E94
48x	E1
12x	E90
11x	E92
8x	E91
29x	E93
3x	E74
3x	E95
3x	E97
6x	E96
9x	WD52
1x	V002

[cm]

vinci
play

E95

E1

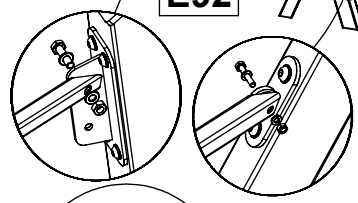
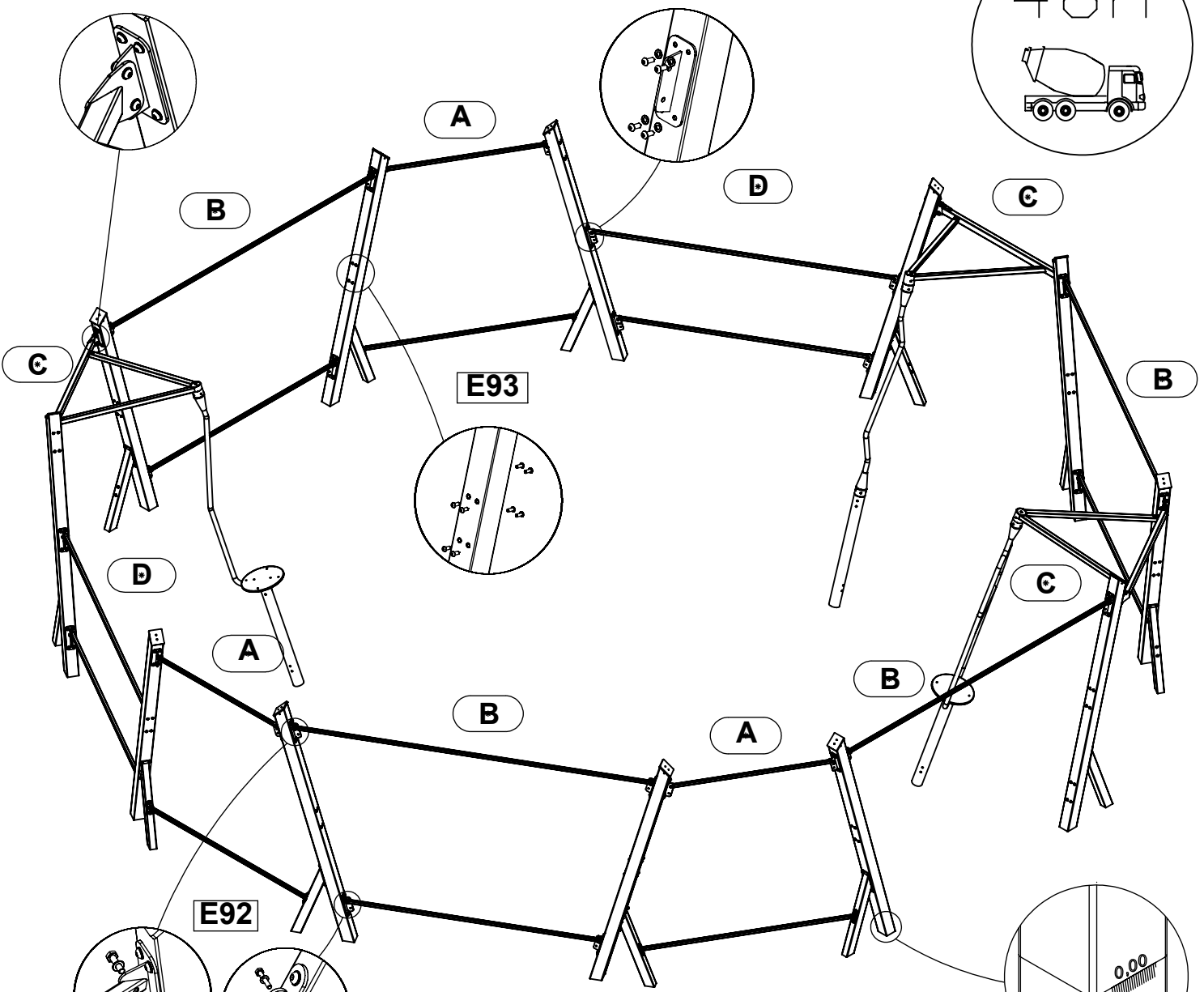
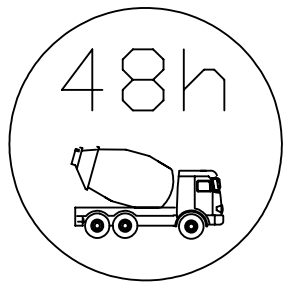

E74

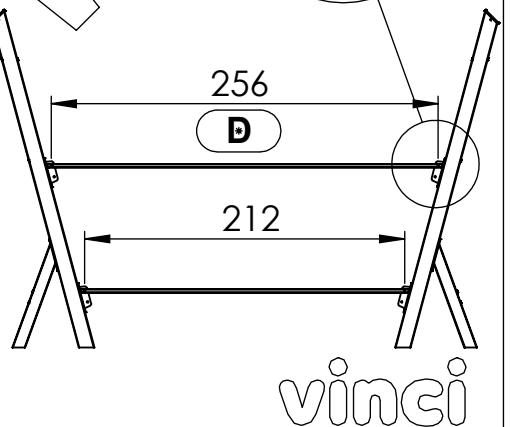
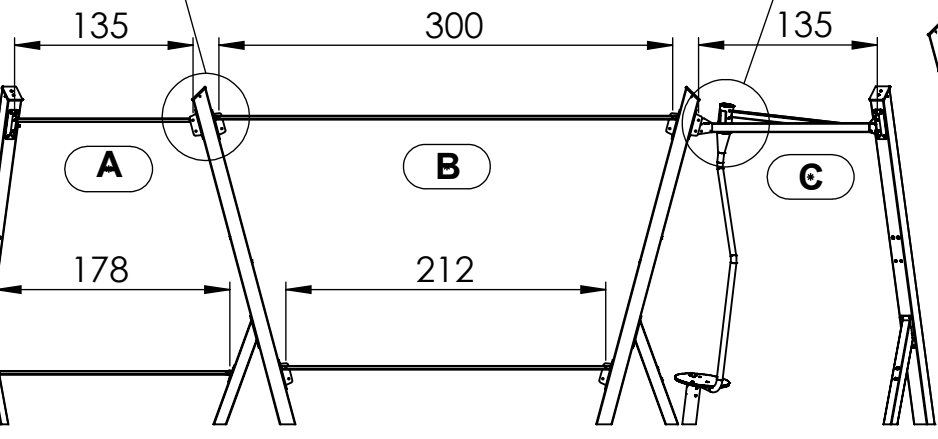
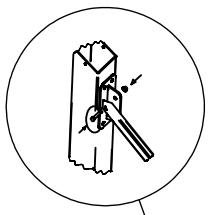
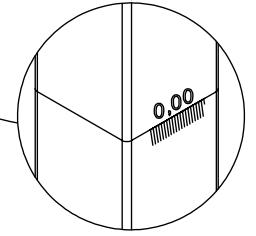

[cm]

vinci play

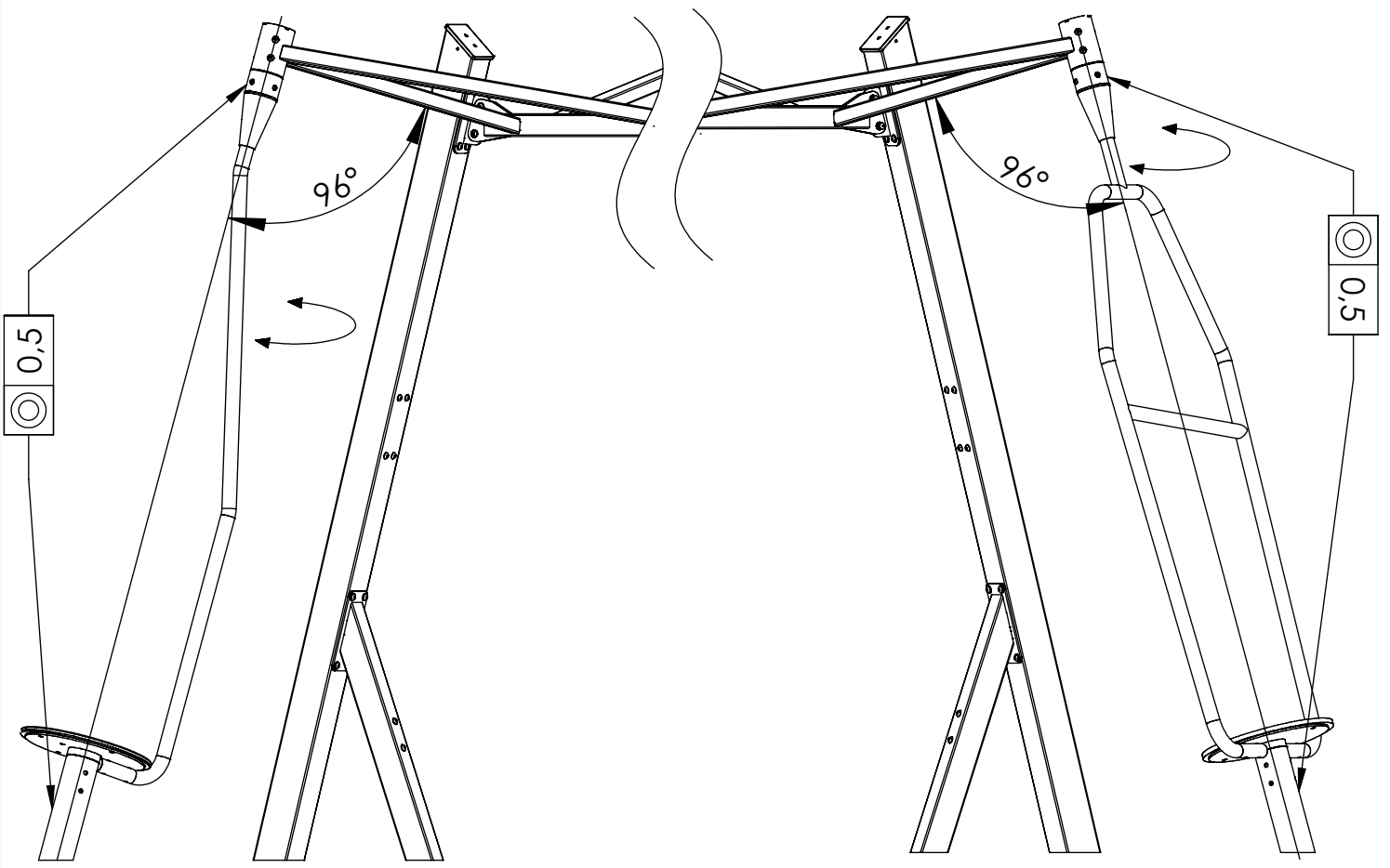
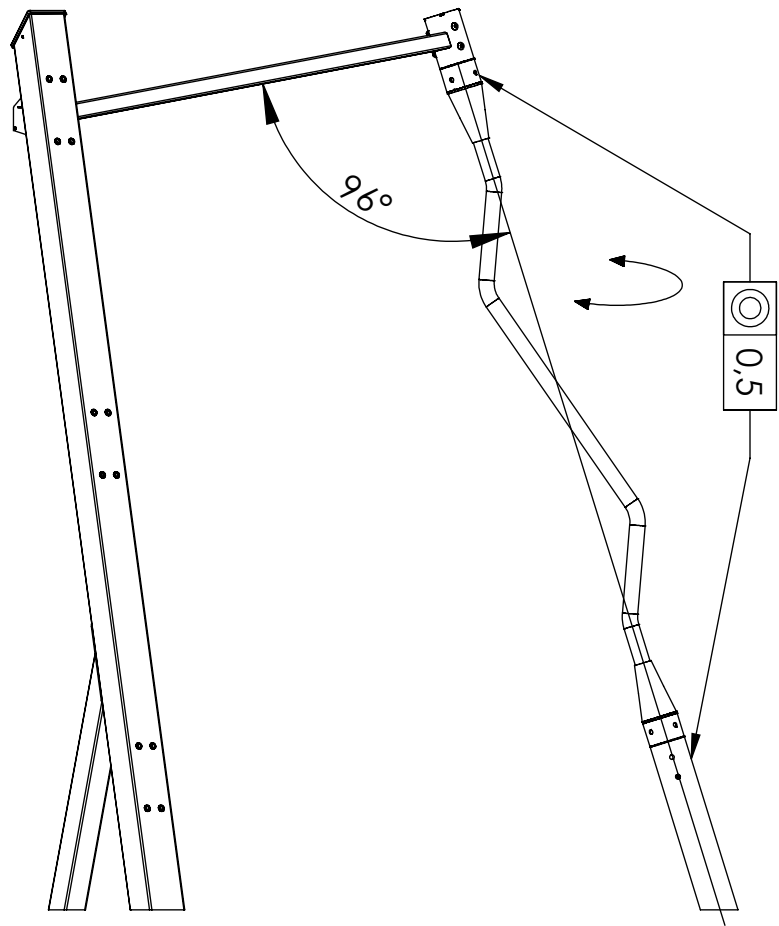

[cm]

vinci
play

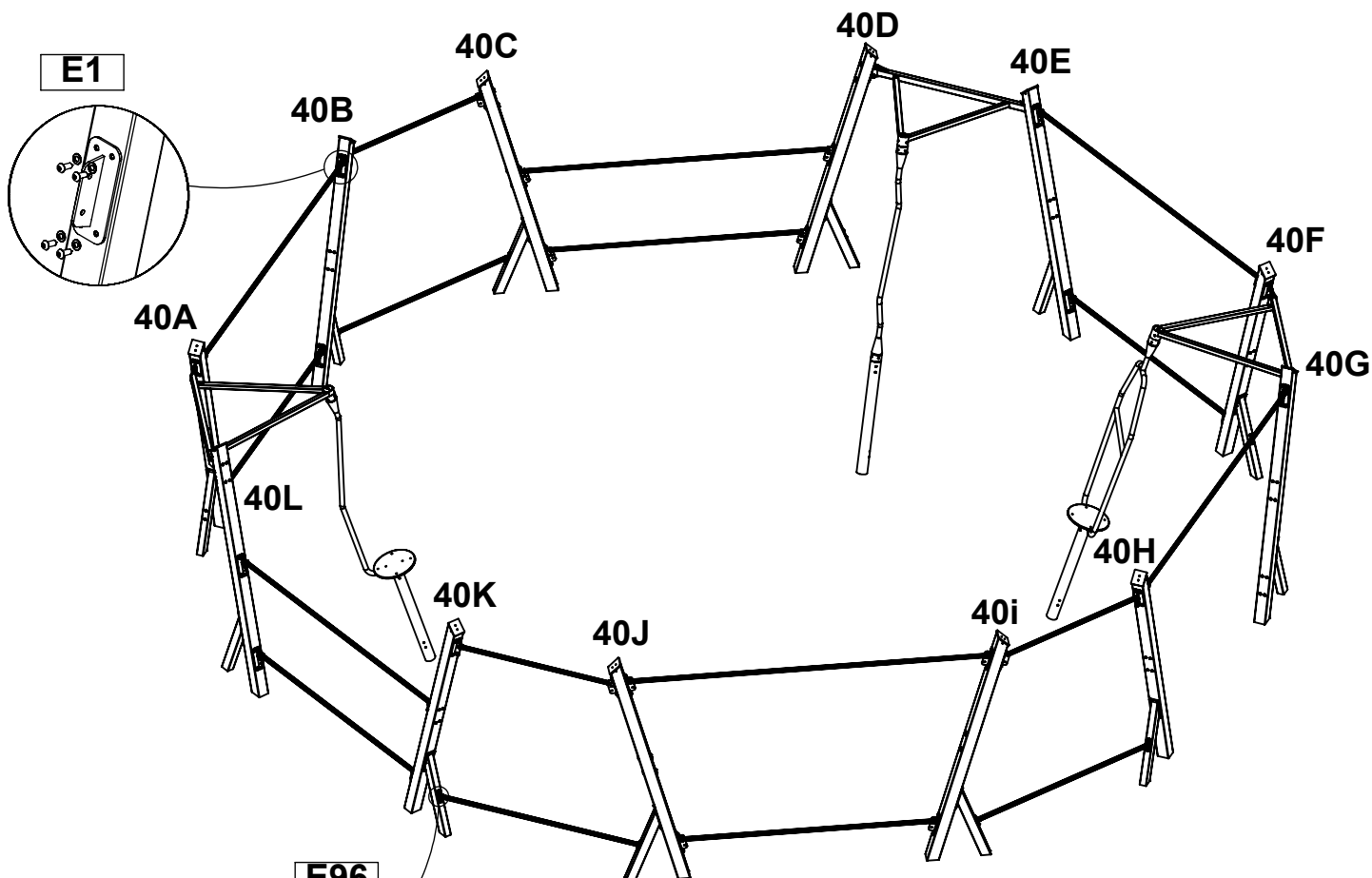

E96

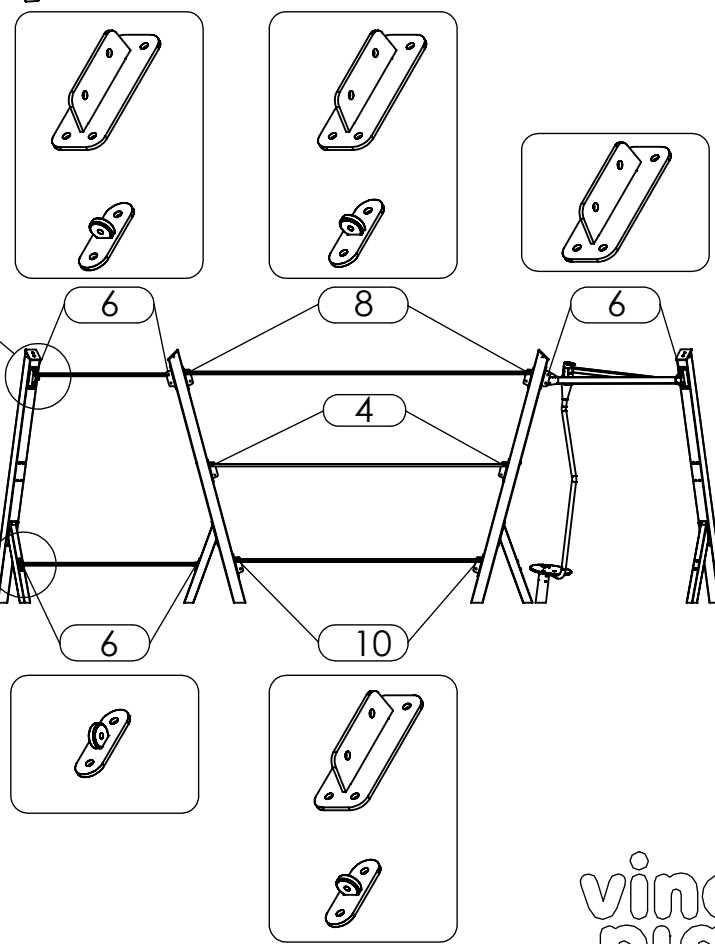
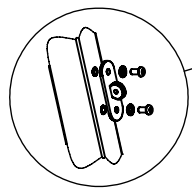
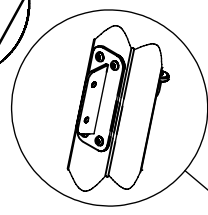
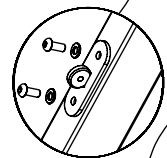

[cm]

vinci play

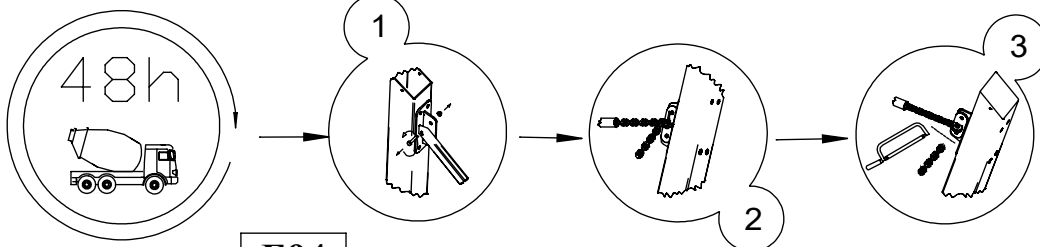

E94

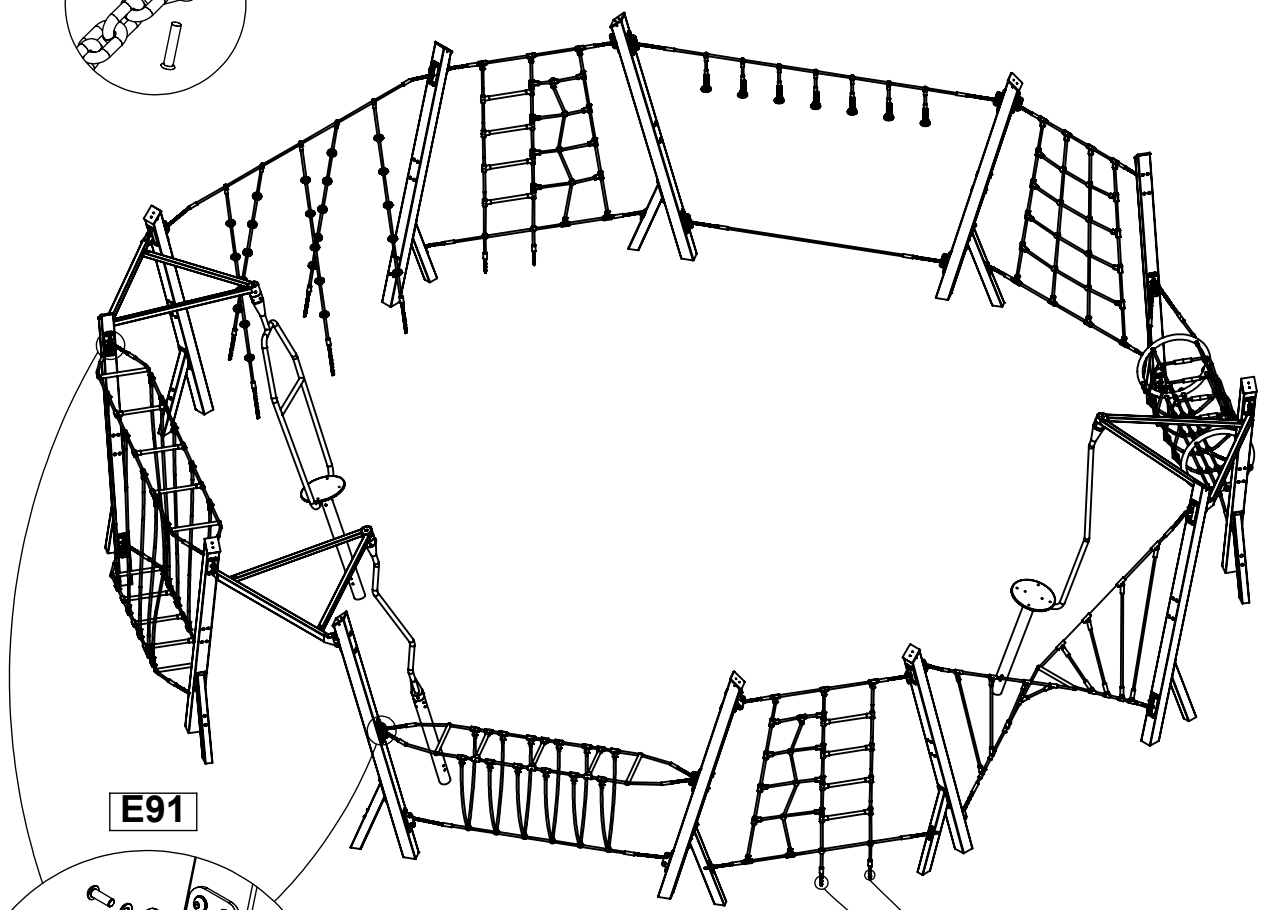
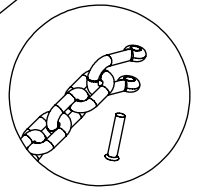
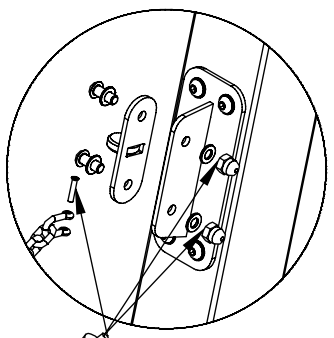

E91

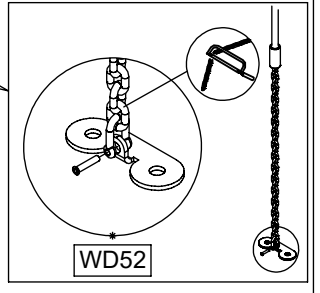
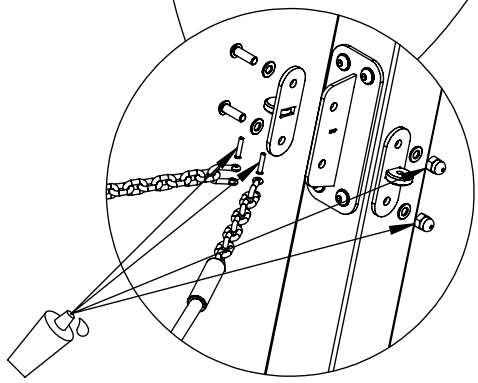

vinci
play

[cm]

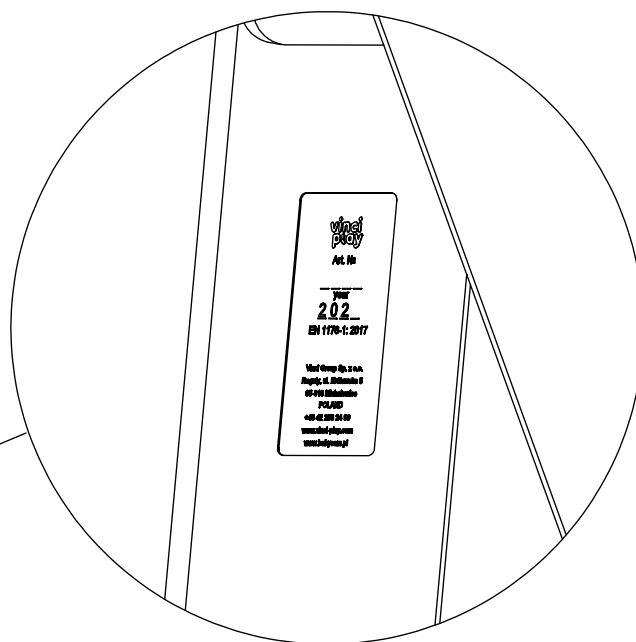
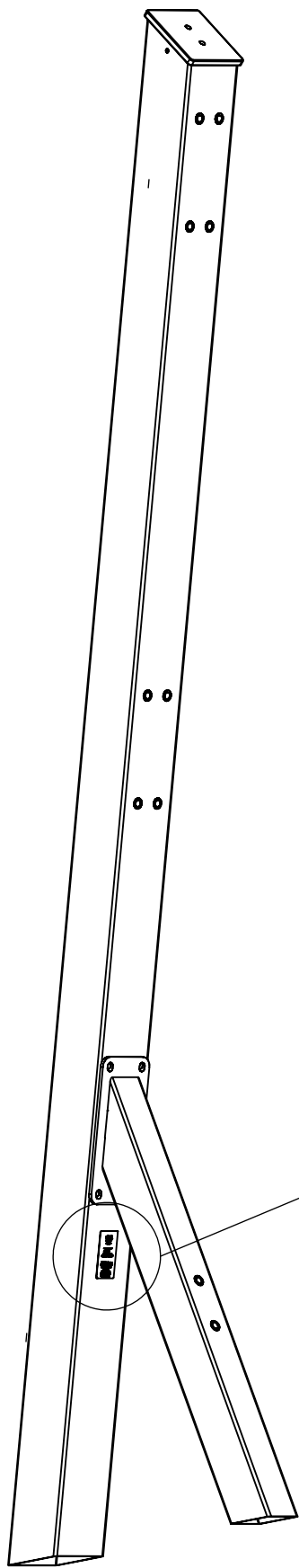

1x V002

[cm]

vinci
play