

# 1632

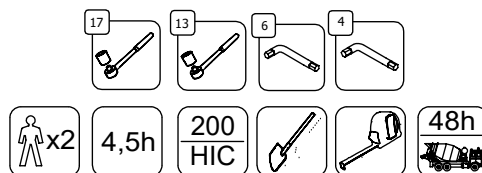

v011  
19.02.2022  
A. D.  
[cm]

vinci  
play

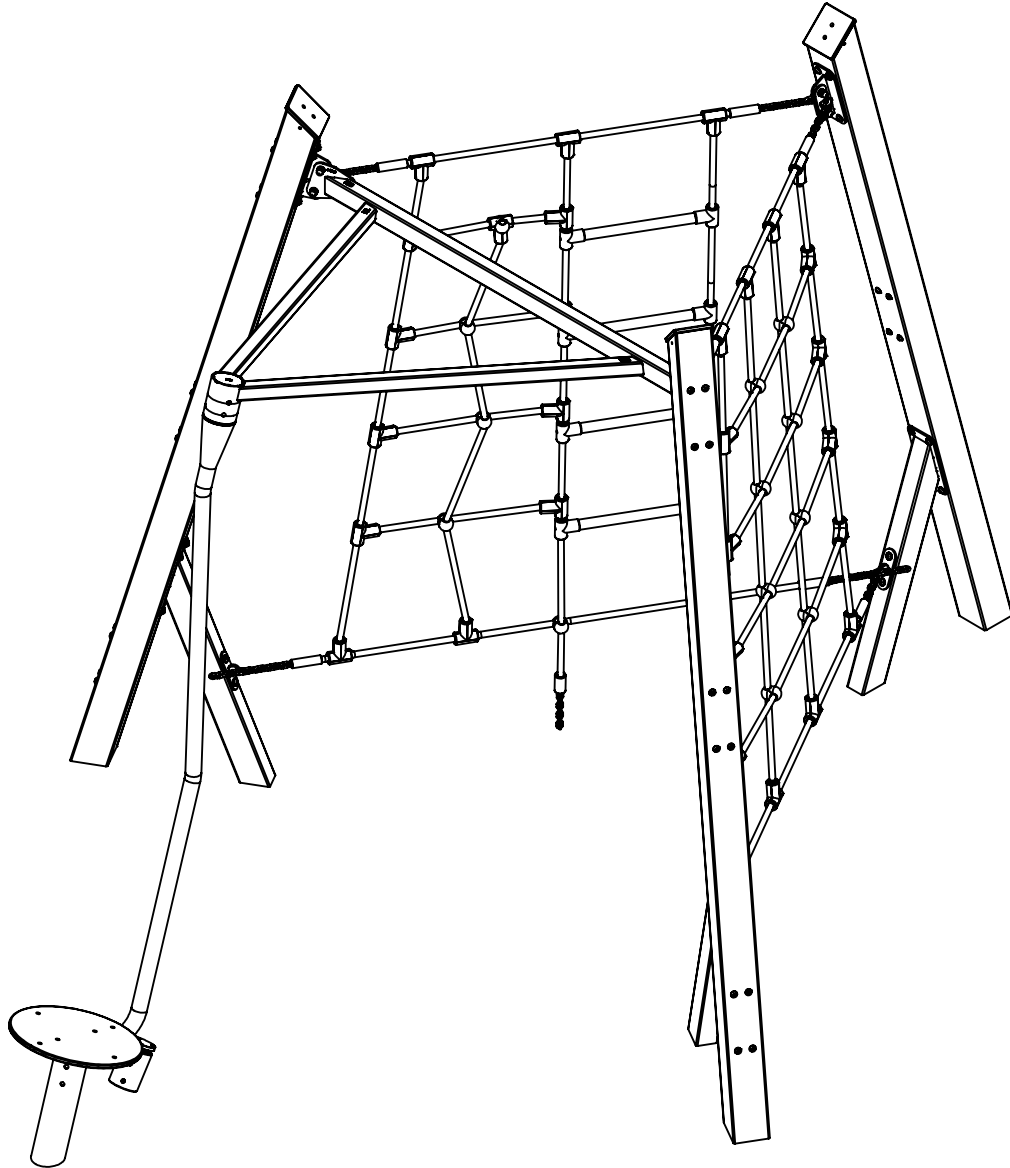
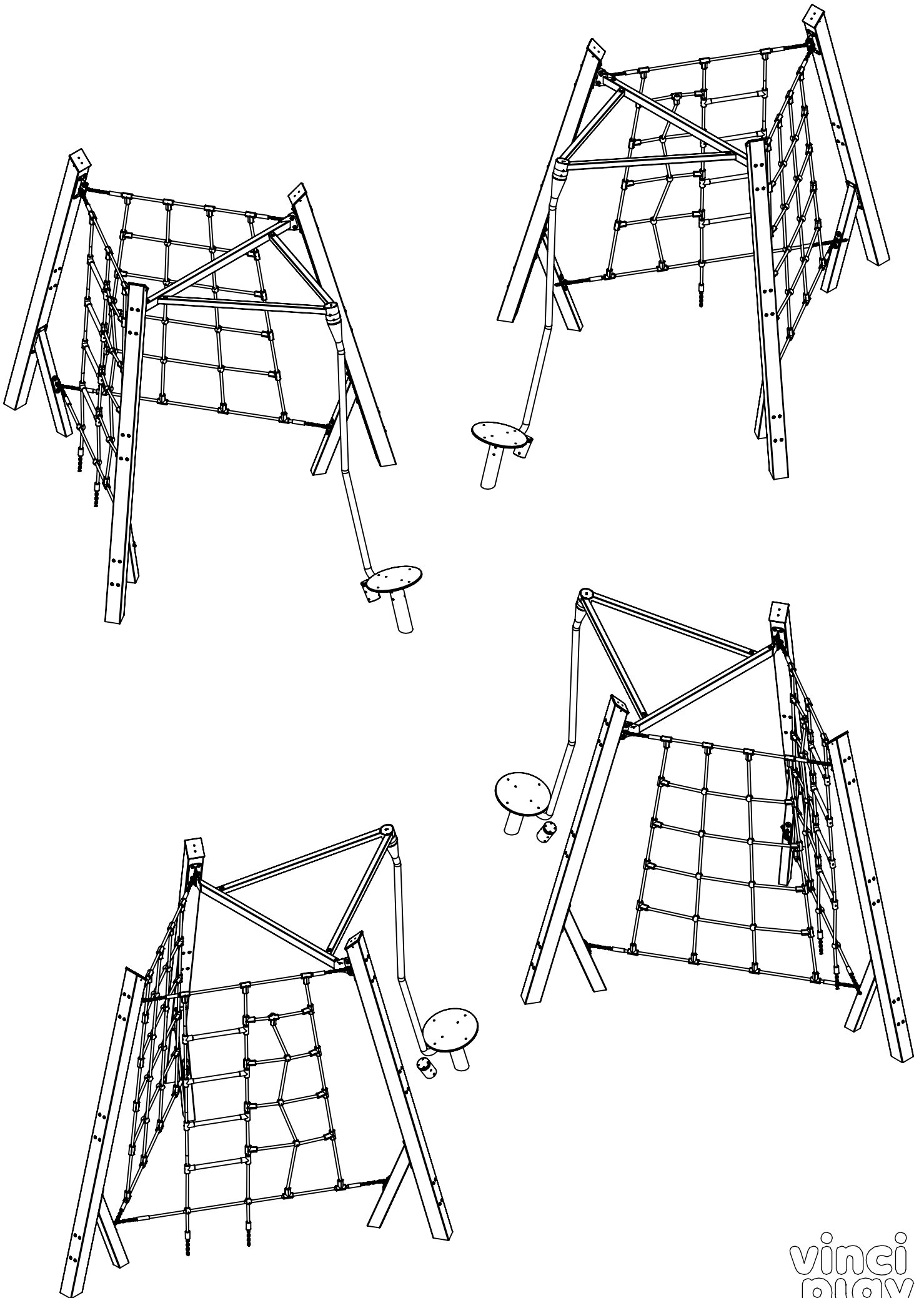

[cm]

vinci  
play

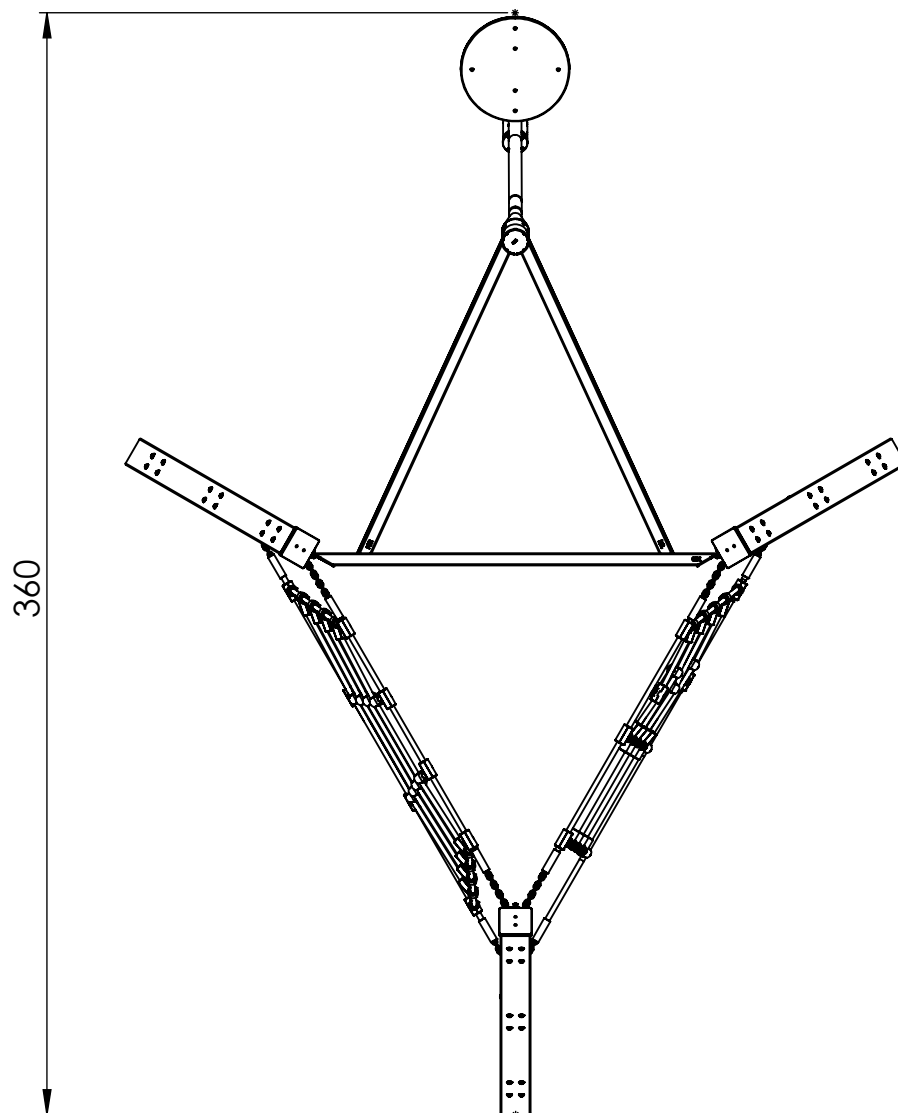
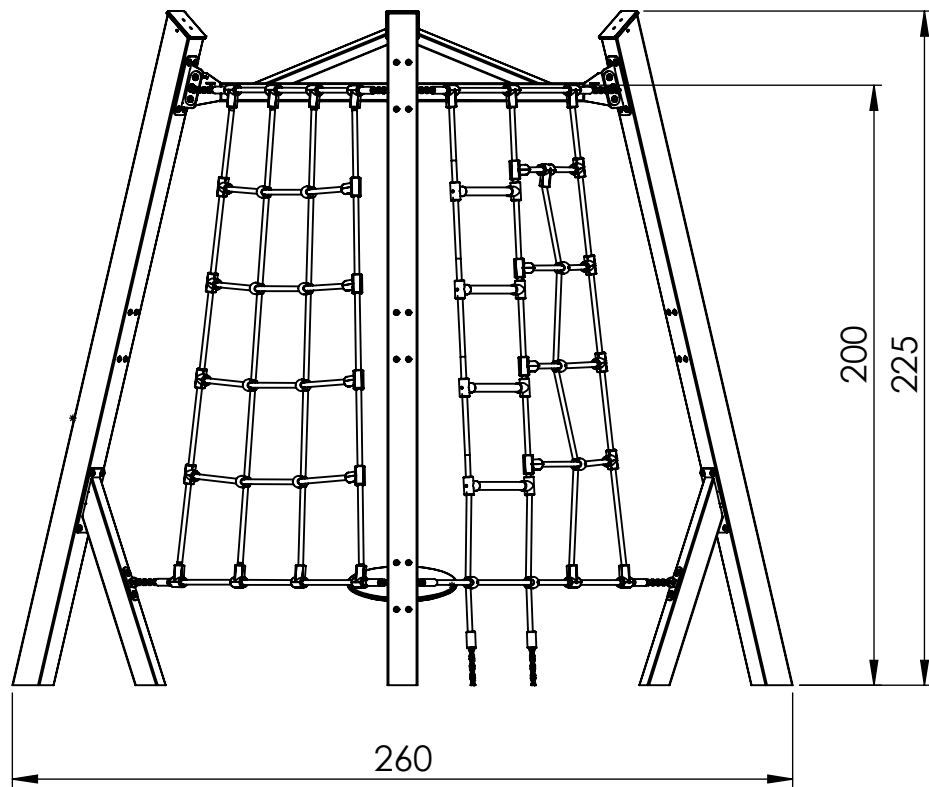

[cm]

vinci  
play

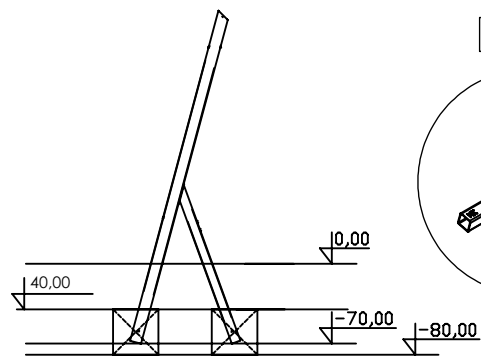

E90

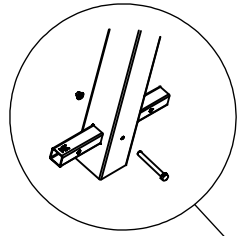

E1

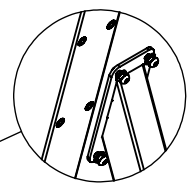

A.

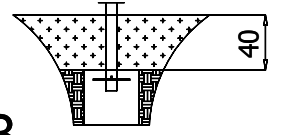

B.

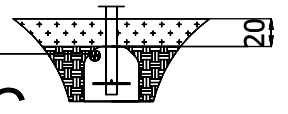

C.

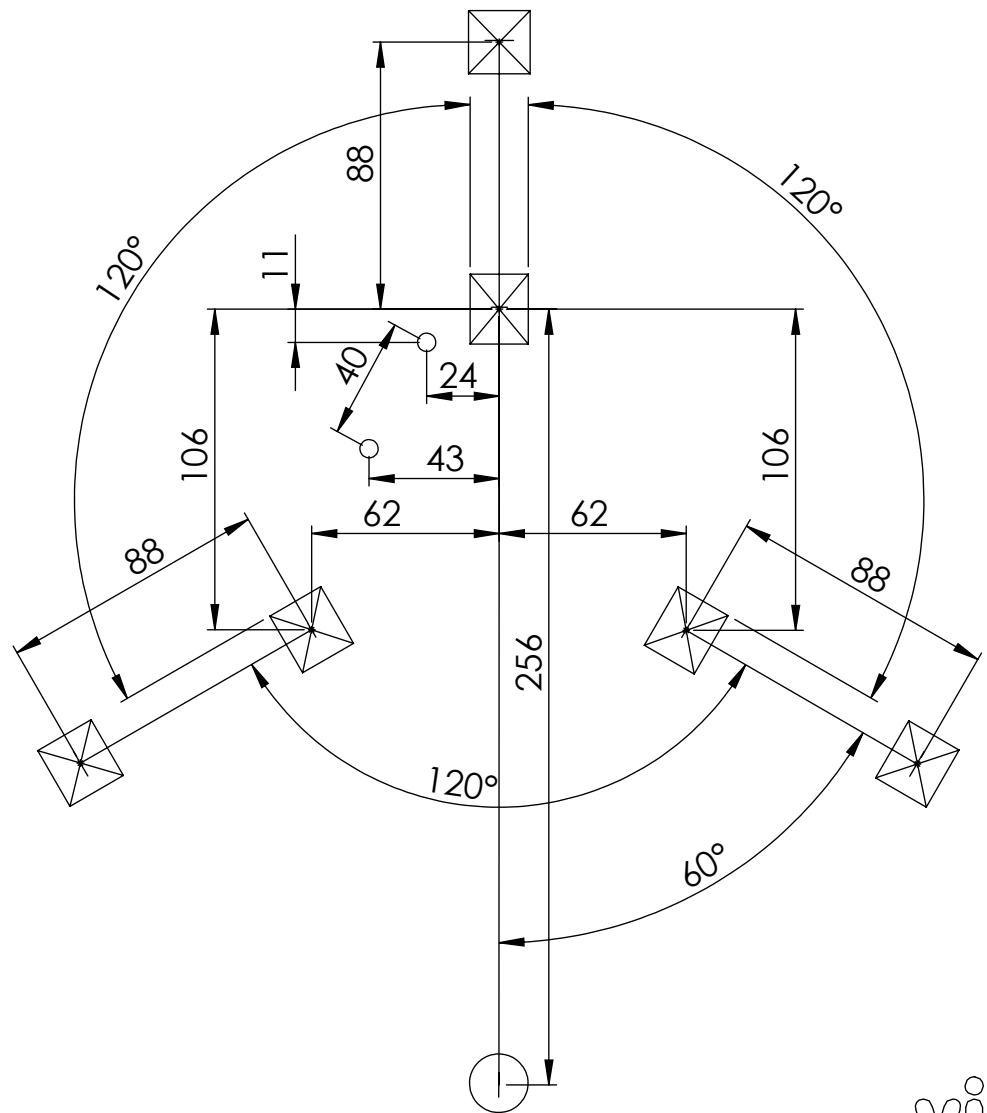
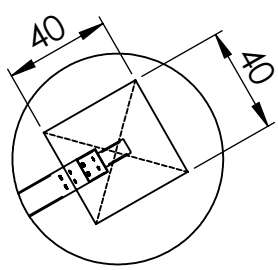
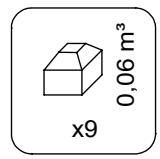
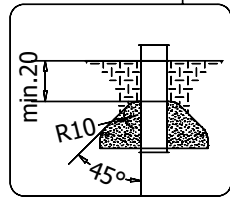
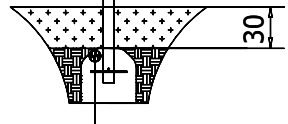

[cm]

vinci play

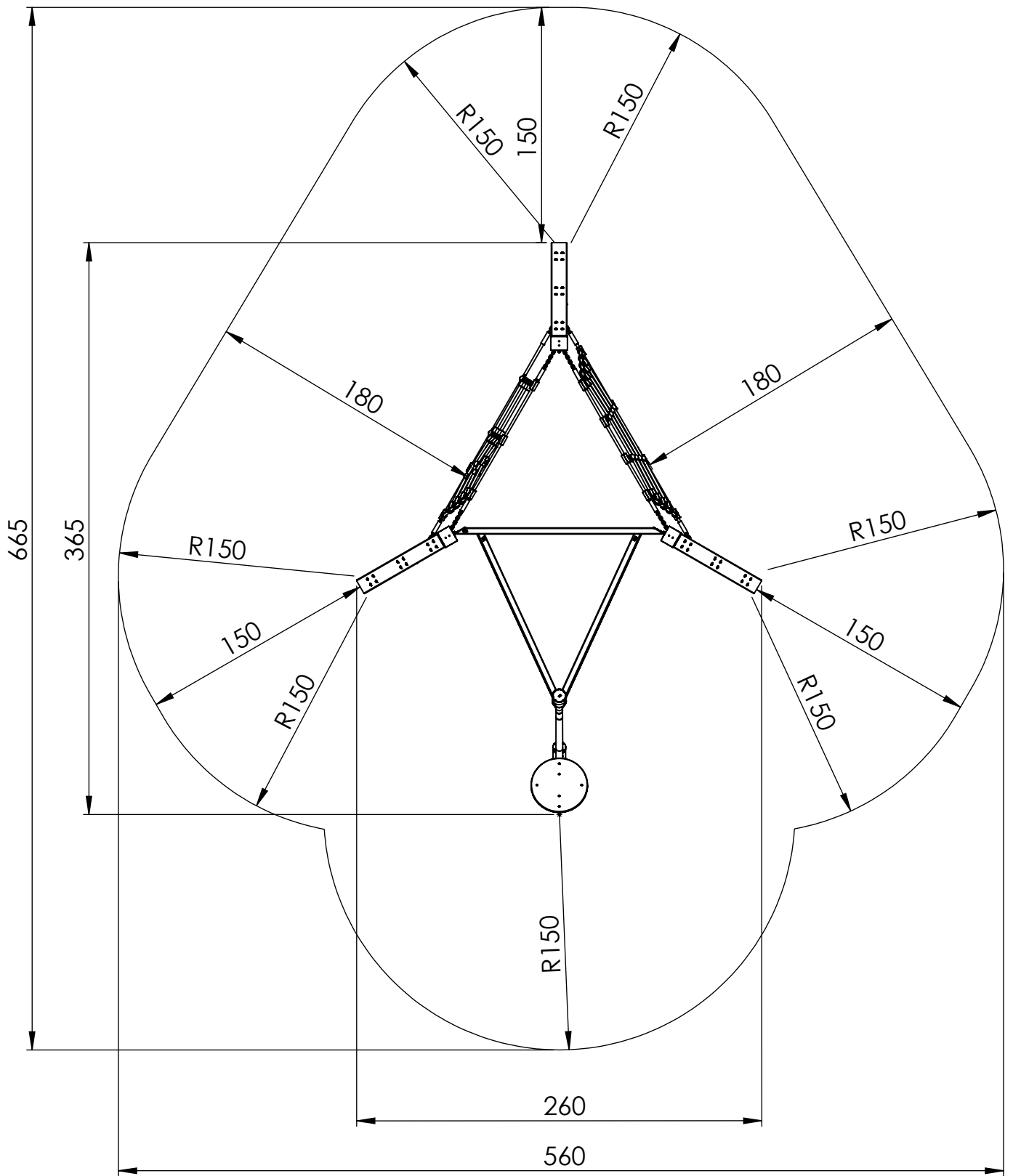

[cm]

vinci  
play



**164104**  
x3

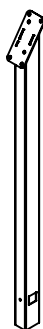

**162100**  
x3

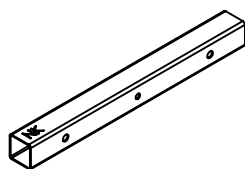

**NK\_kotw\_1**  
x6

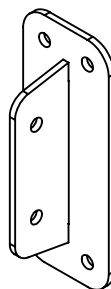

**162101**  
x3

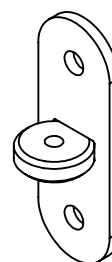

**162102**  
x4



**162103**  
x3

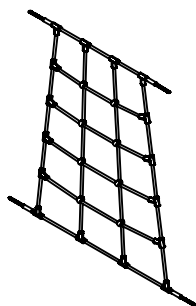

**165111**  
x1

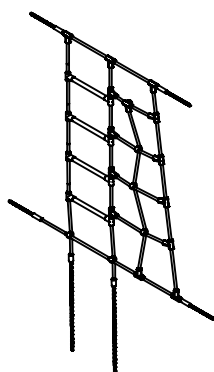

**165112**  
x1

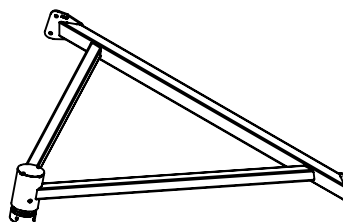

**164100**  
x1

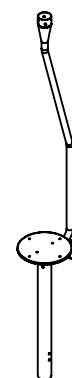

**164102**  
x1

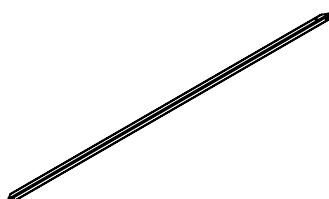

**163103**  
x2

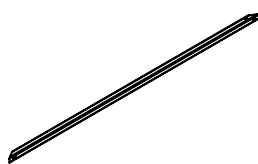

**163104**  
x3

6x	E1
1x	E66
1x	E74
3x	E90
12x	E93
3x	E96
1x	E98
1x	E99
2x	WD52
1x	V002

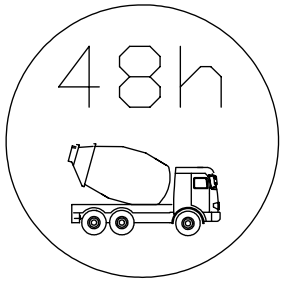

E74

E1

E98

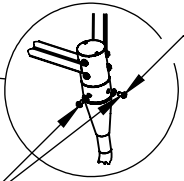
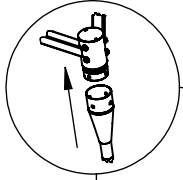

m10x20

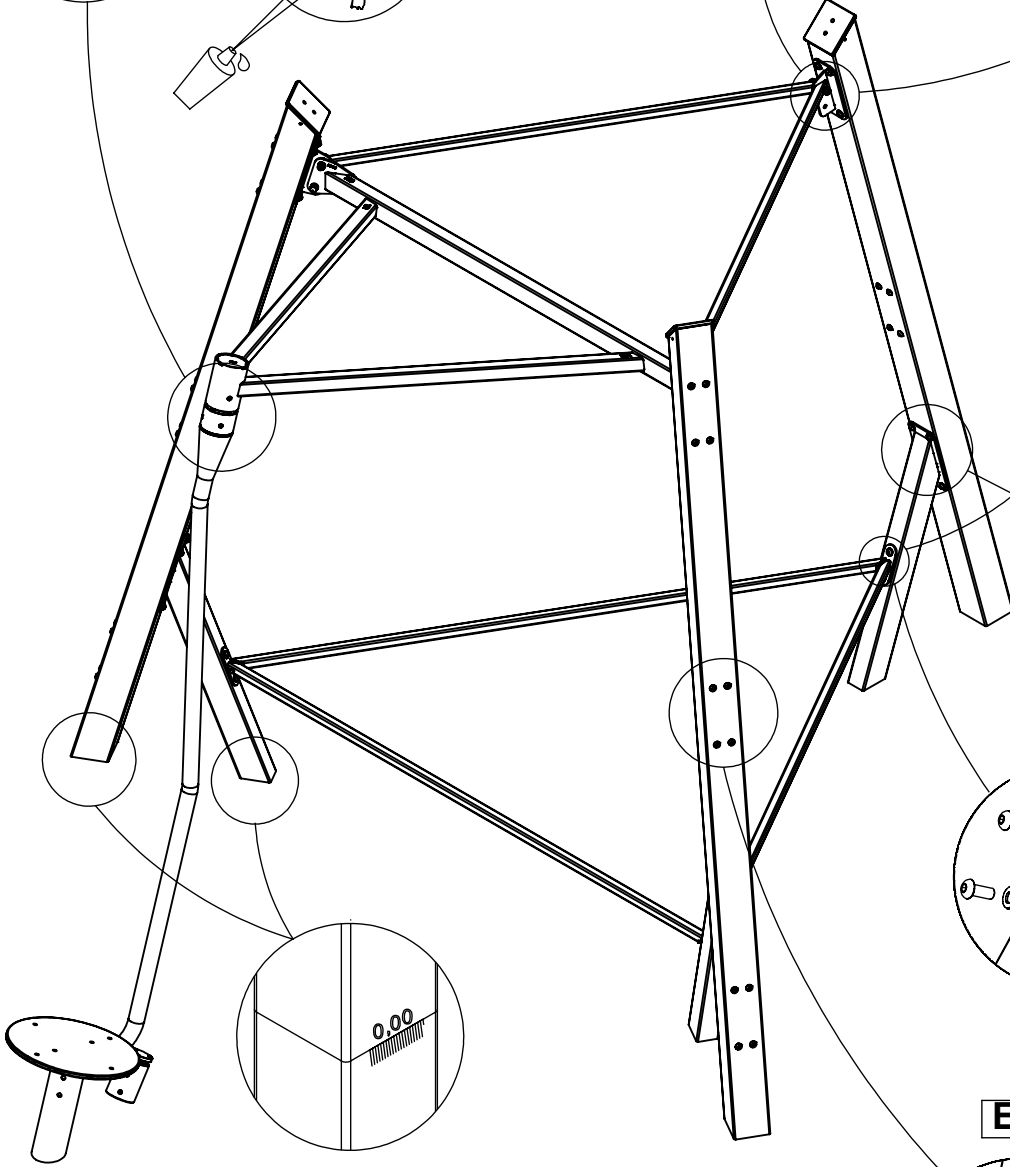
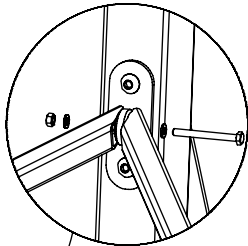
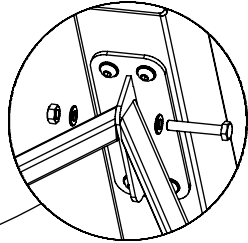
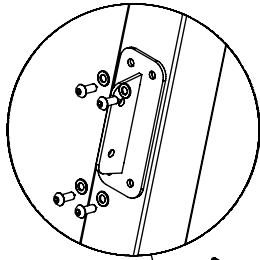

E1

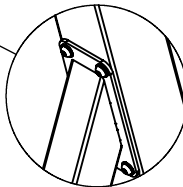

E96

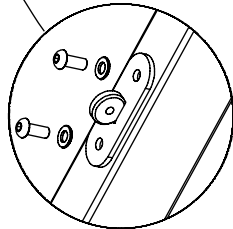

E93

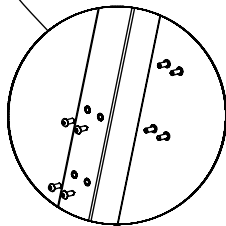

[cm]

vinci  
play

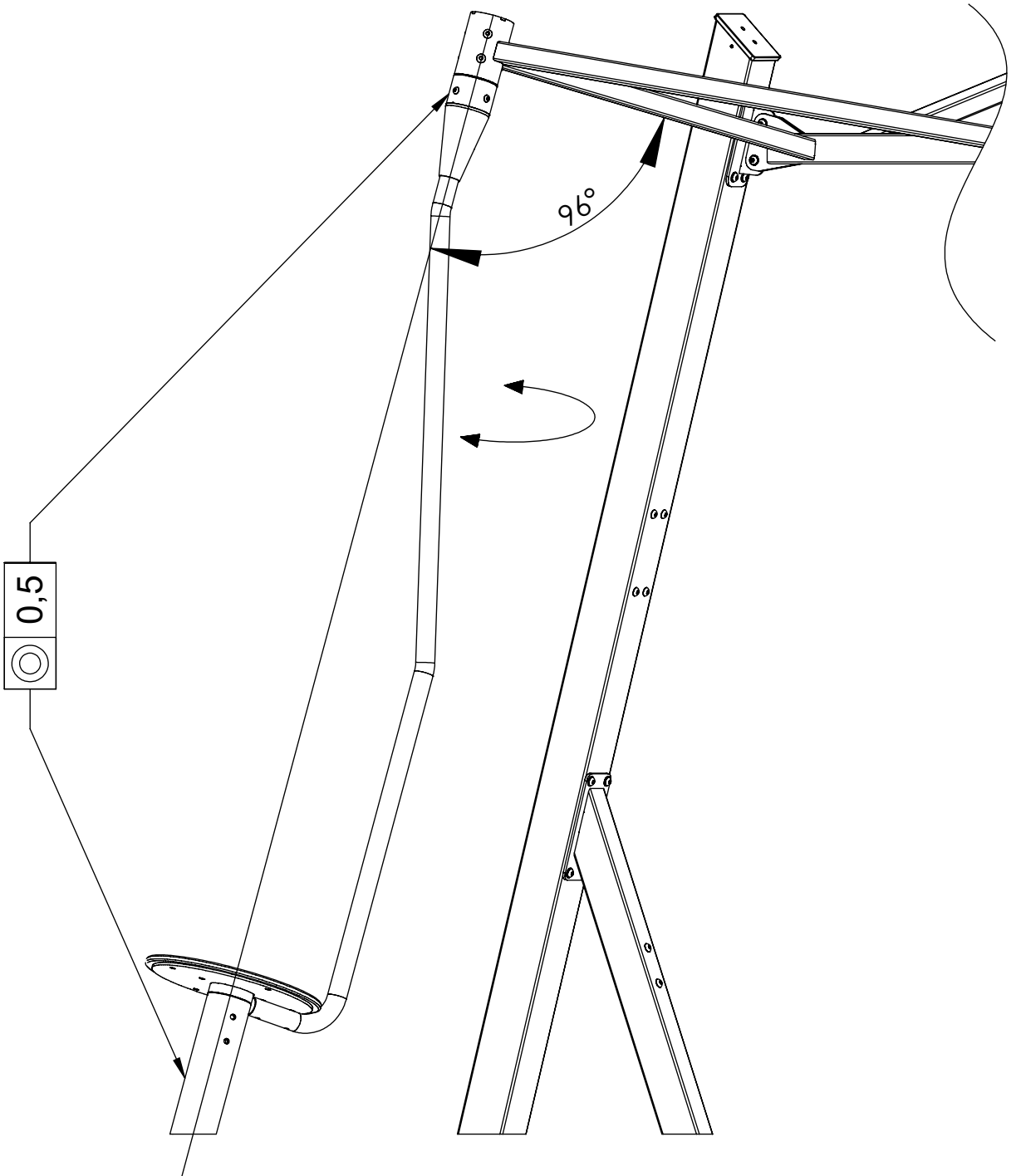

[cm]

vinci  
play



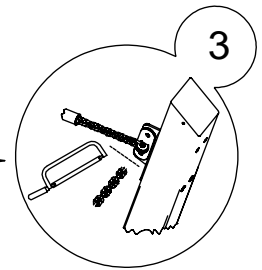
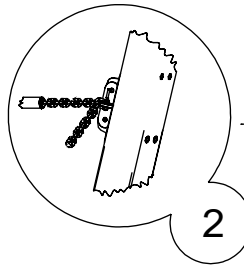
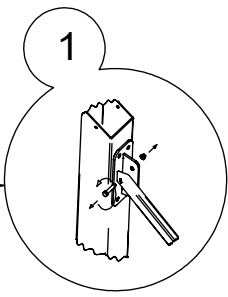
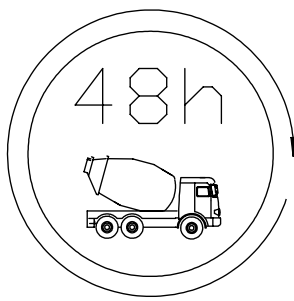

E99

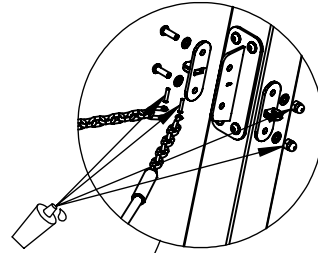

E66

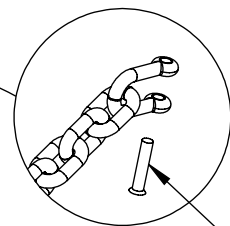

E96

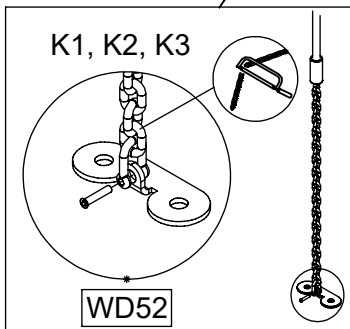
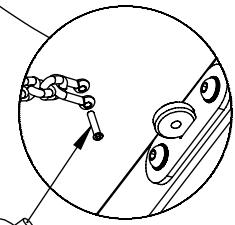

[cm]

vinci  
play

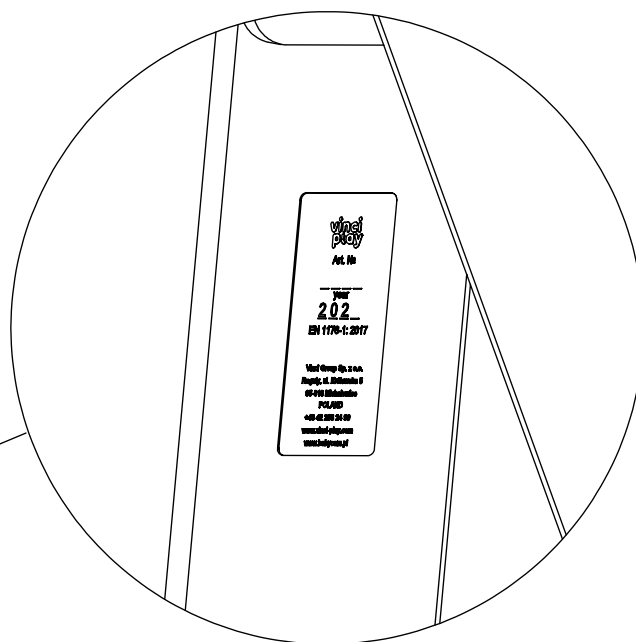
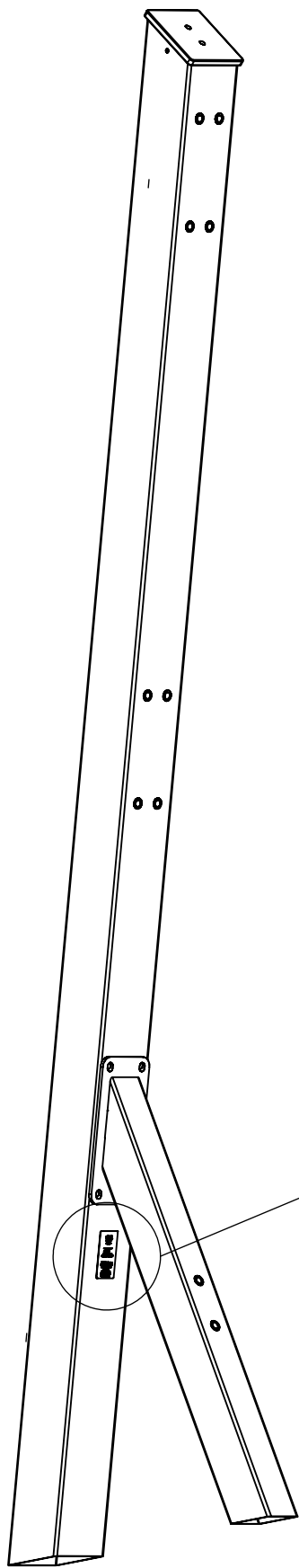

1x V002

[cm]

vinci  
play