

1630

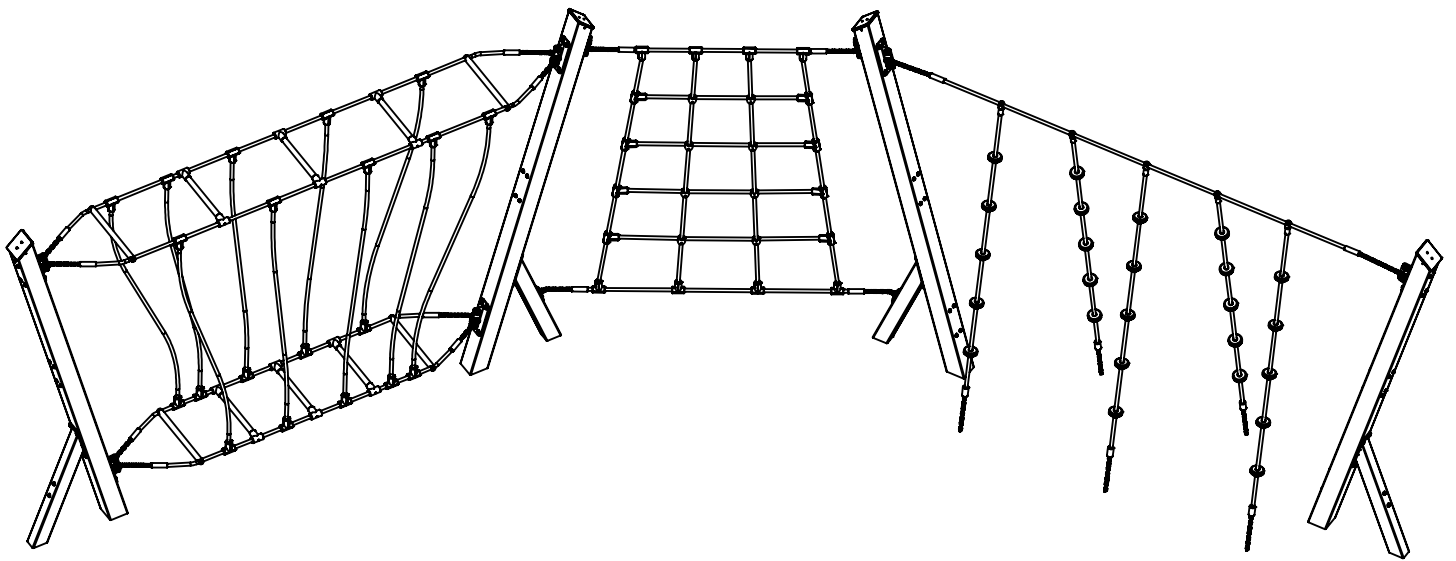

v012
12.02.2022
A. D.
[cm]

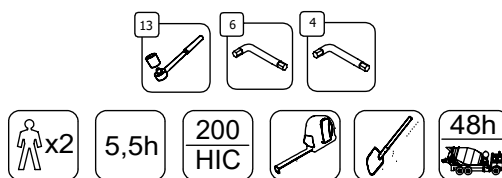

vinci
play

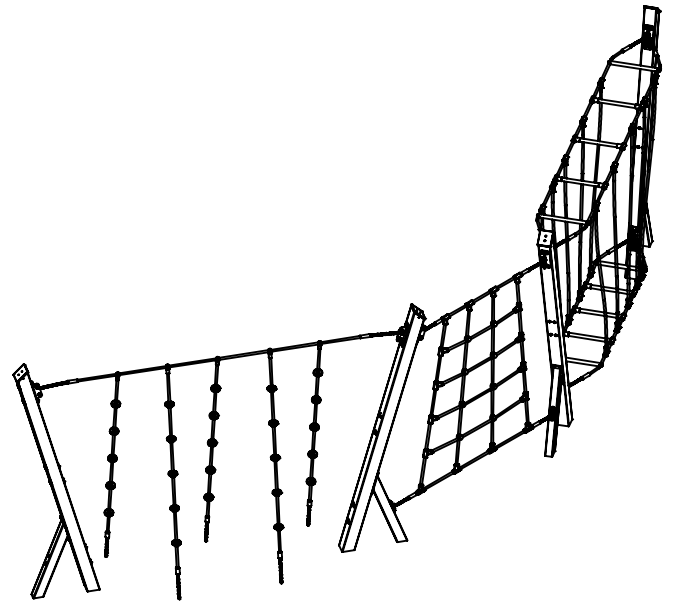
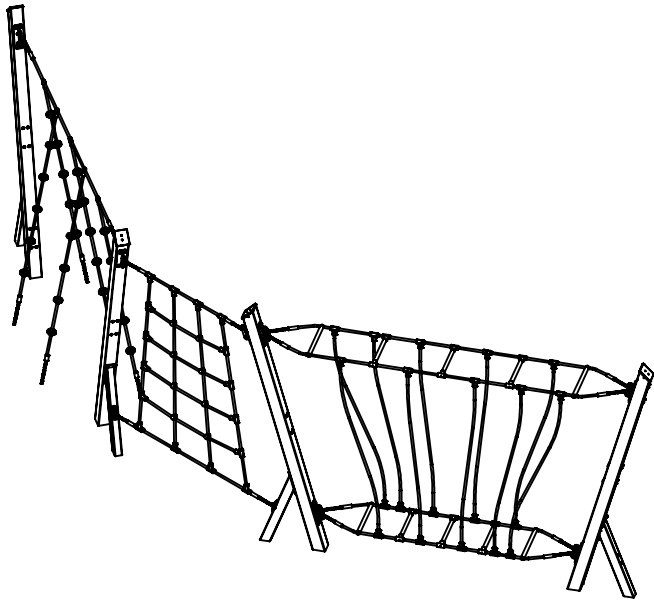
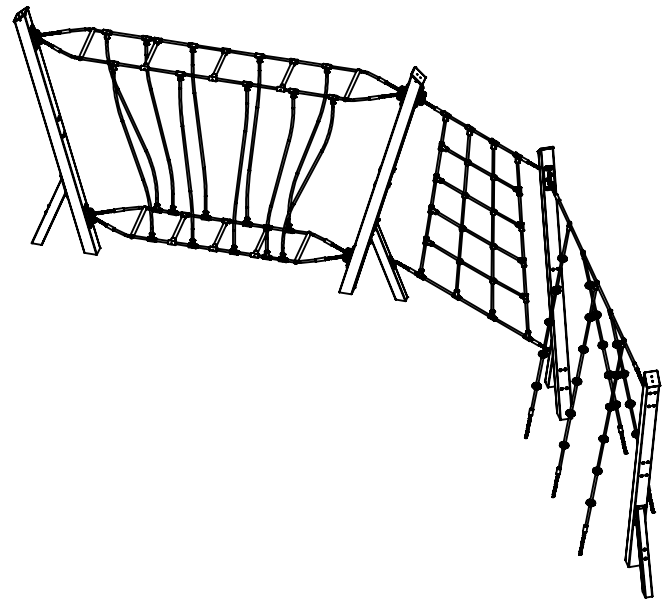
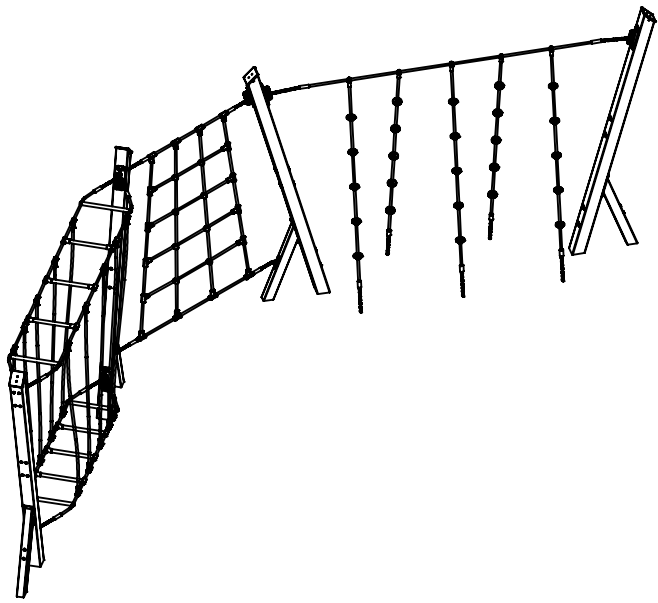

[cm]

vinci
play

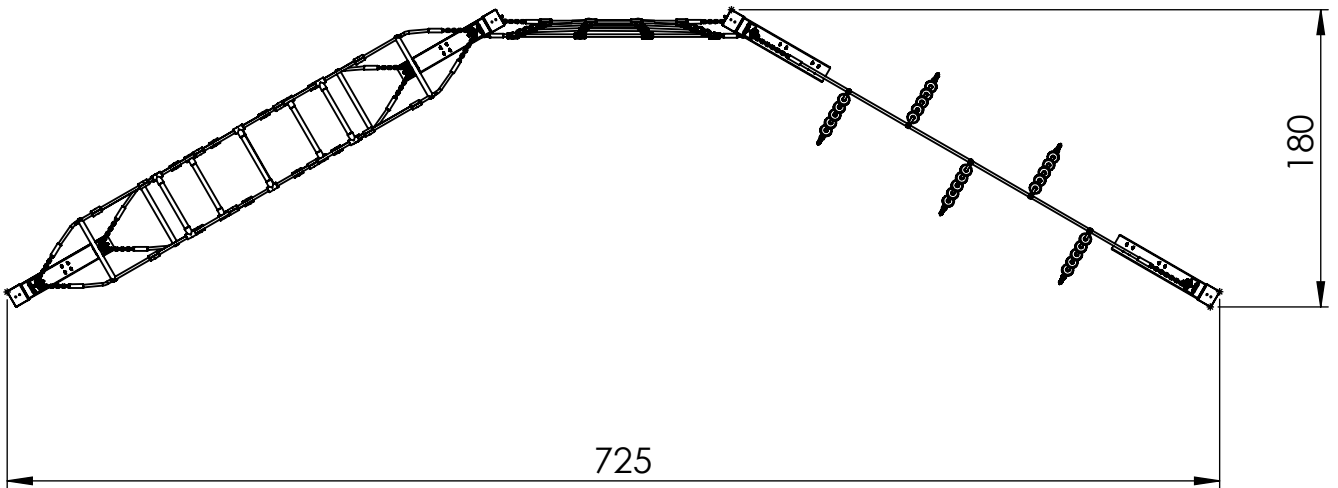
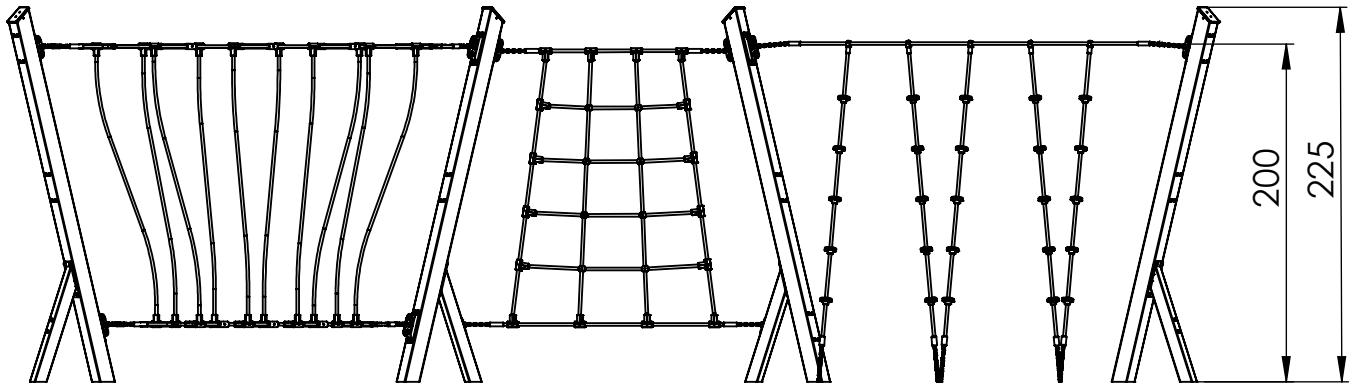

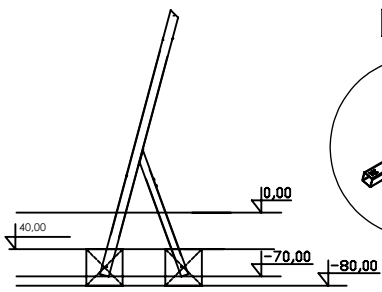

E90

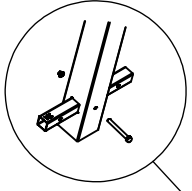

E1

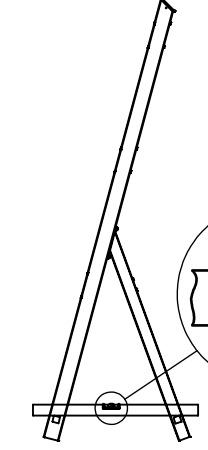
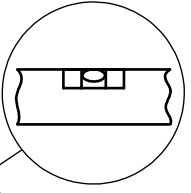
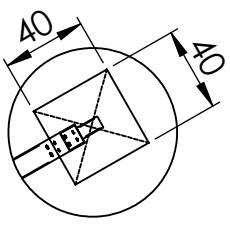
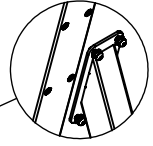

A.

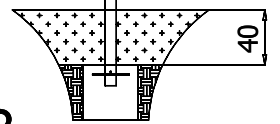

B.

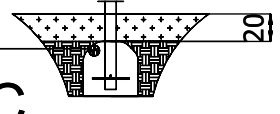

C.

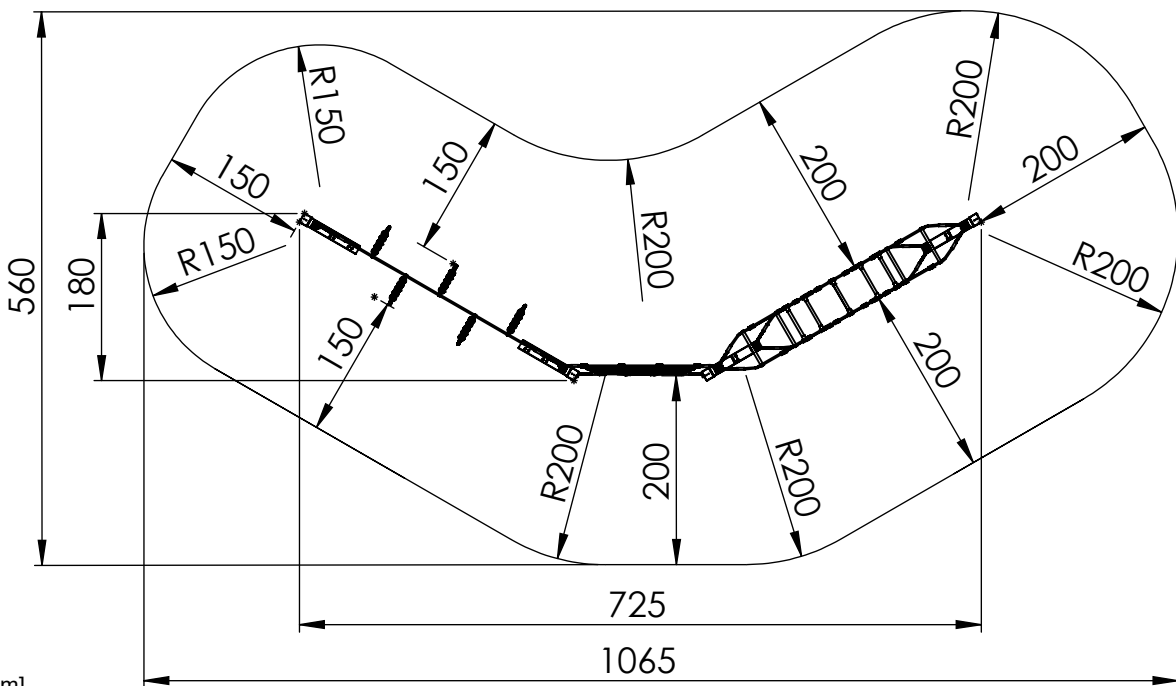
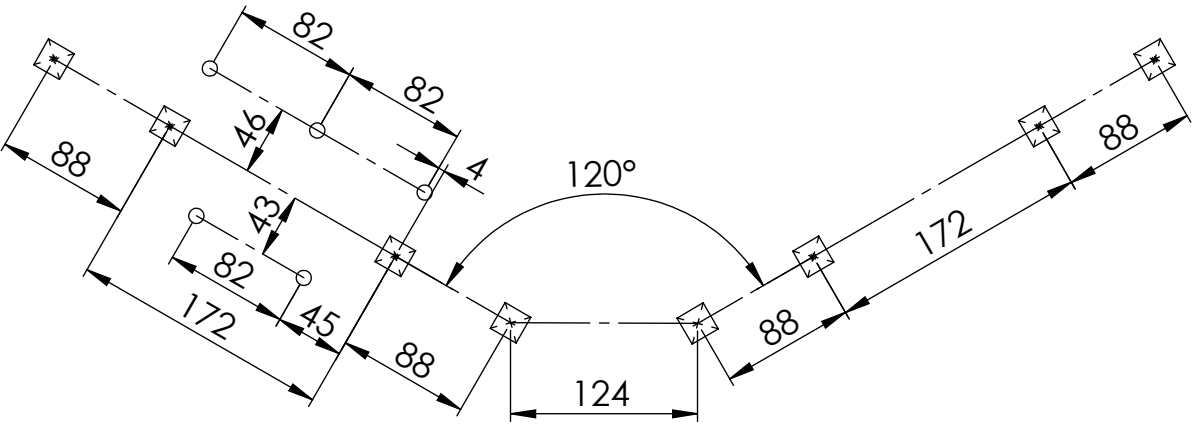
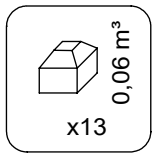
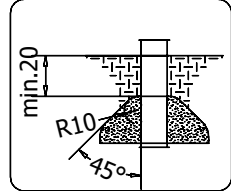
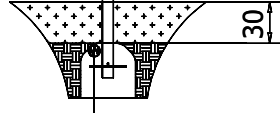

[cm]

vinci
play



162100
x4



162100
x4

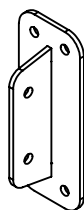

162101
x8

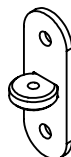

162102
x12



162103
x2

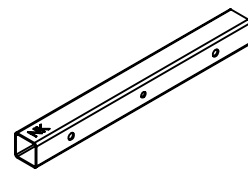

NK_kotw_1
x8

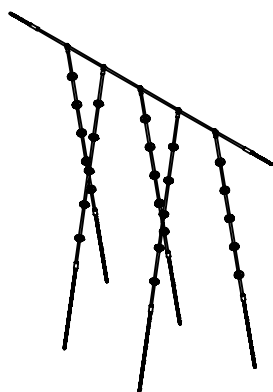

165102
x1

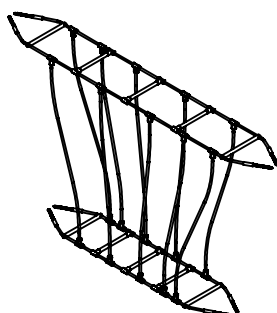

165105
x1

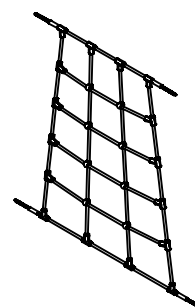

165111
x1

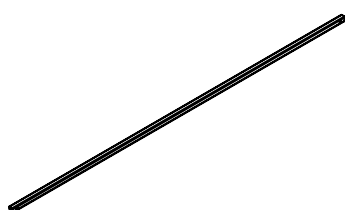

163100
x1

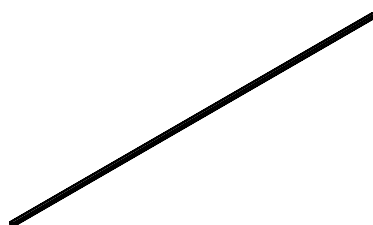

163101
x2

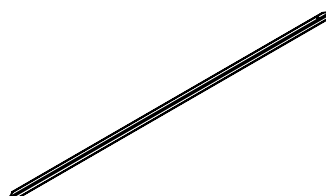

163103
x1

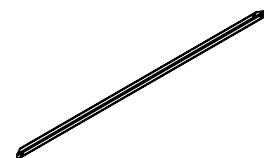

163104
x1

12x	E1
4x	E90
4x	E91
3x	E92
13x	E93
2x	E94
2x	E96
1x	E97
5x	WD52
1x	V002

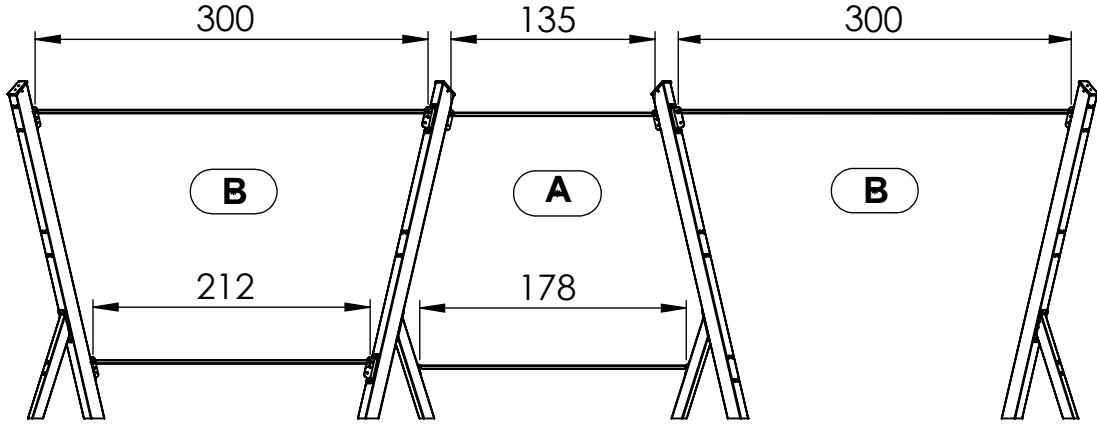
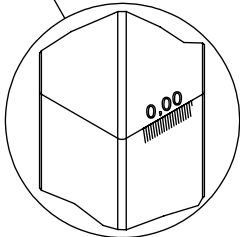
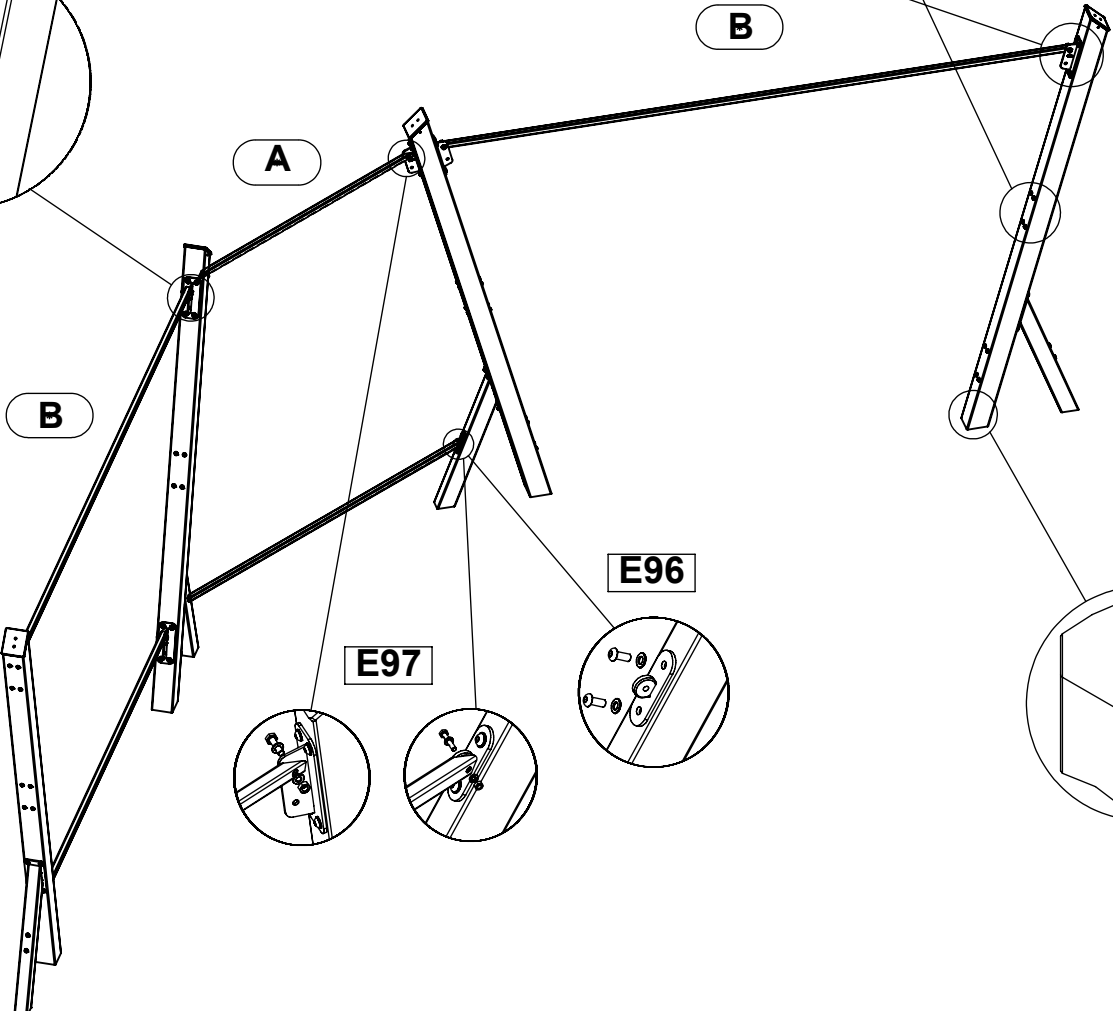
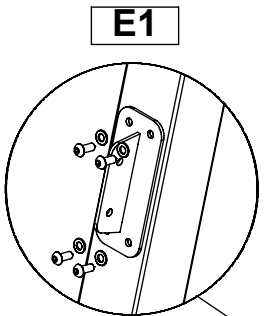
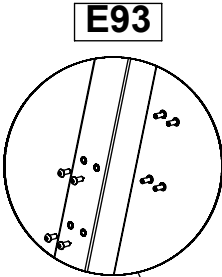
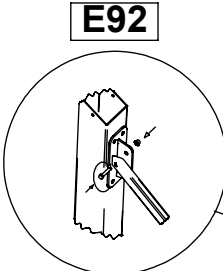
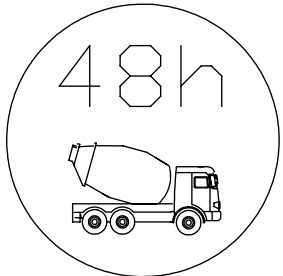

[cm]

vinci
play

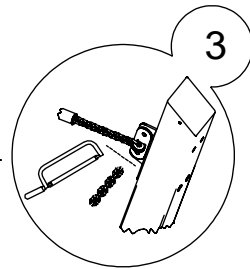
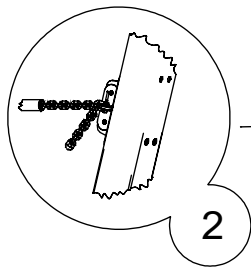
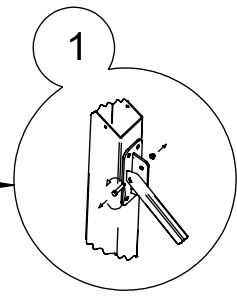
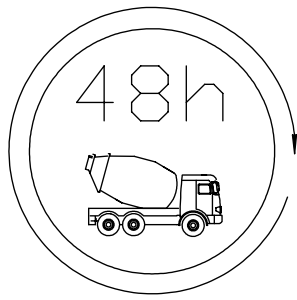

E91

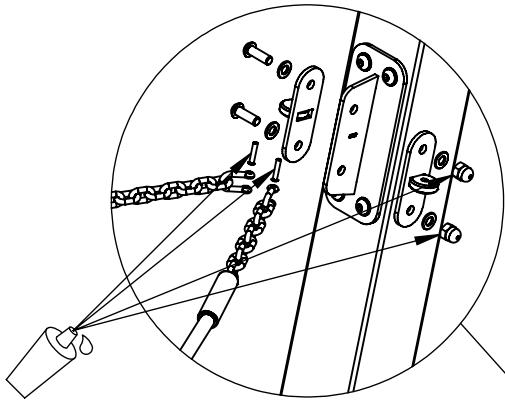

E94

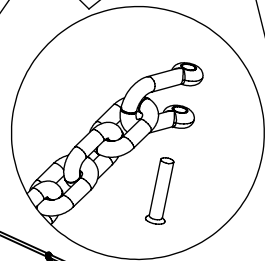
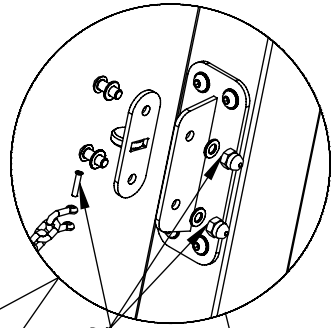

E96

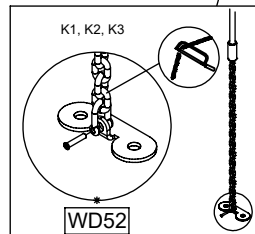
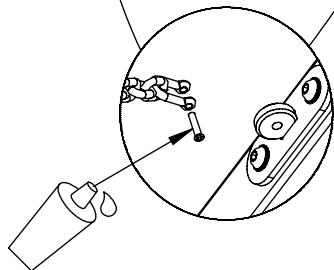

[cm]

vinci
play

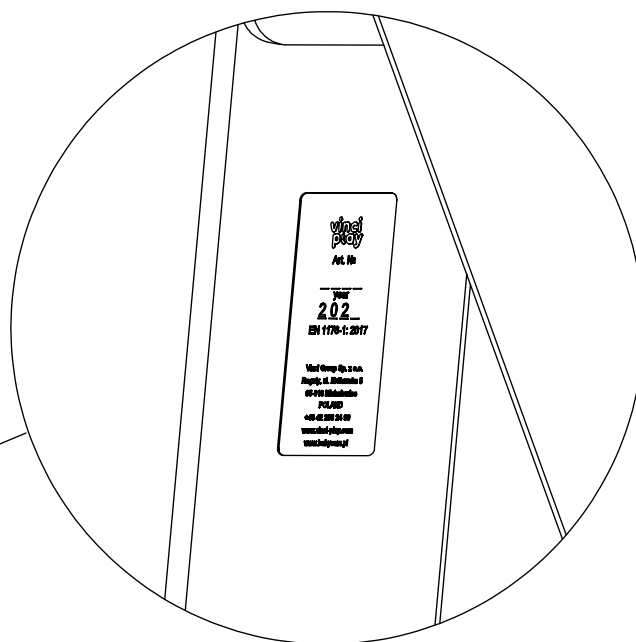
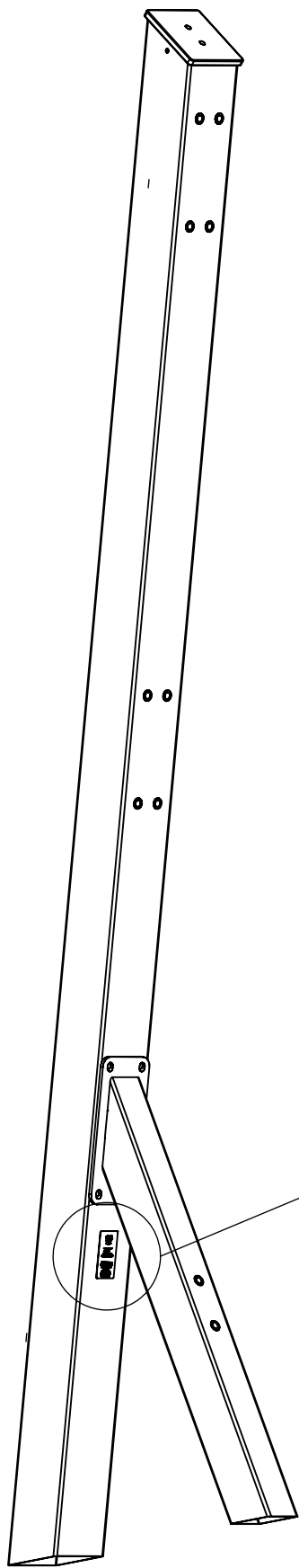

1x V002

[cm]

vinci
play